



MEDICO

TECHNOLOGIES



Surgical

Instruments

Catalog **2021**



STOMAC INSTRUMENTS RECTUM

Intestinal and Tissue Grasping Forceps
Darm- und Gewebefasszangen
Pinzas para intestinos y tejidos
Pincas pour saisir intestins et tissus
Pinze per afferrare intestino e tessuti

Allis-Baby Intestinal and Tissue Grasping Forcep

4 x 5 Teeth

Catalog #	Size
MT-SI-14-100	13 cm (5")



Allis Intestinal and Tissue Grasping Forcep

4 x 5 Teeth

Catalog #	Size
MT-SI-14-101	15.5 cm (6")



Allis Intestinal and Tissue Grasping Forcep

5 x 6 Teeth

Catalog #	Size
MT-SI-14-102	15.5 cm (6")
MT-SI-14-103	19 cm (7 1/2")
MT-SI-14-104	25.5 cm (10")



Allis Atrauma Intestinal and Tissue Grasping Forcep

Catalog #	Size
MT-SI-14-105	15.5 cm (6")
MT-SI-14-106	20 cm (8")
MT-SI-14-107	24.5 cm (9 3/4")
MT-SI-14-108	30 cm (11 3/4")

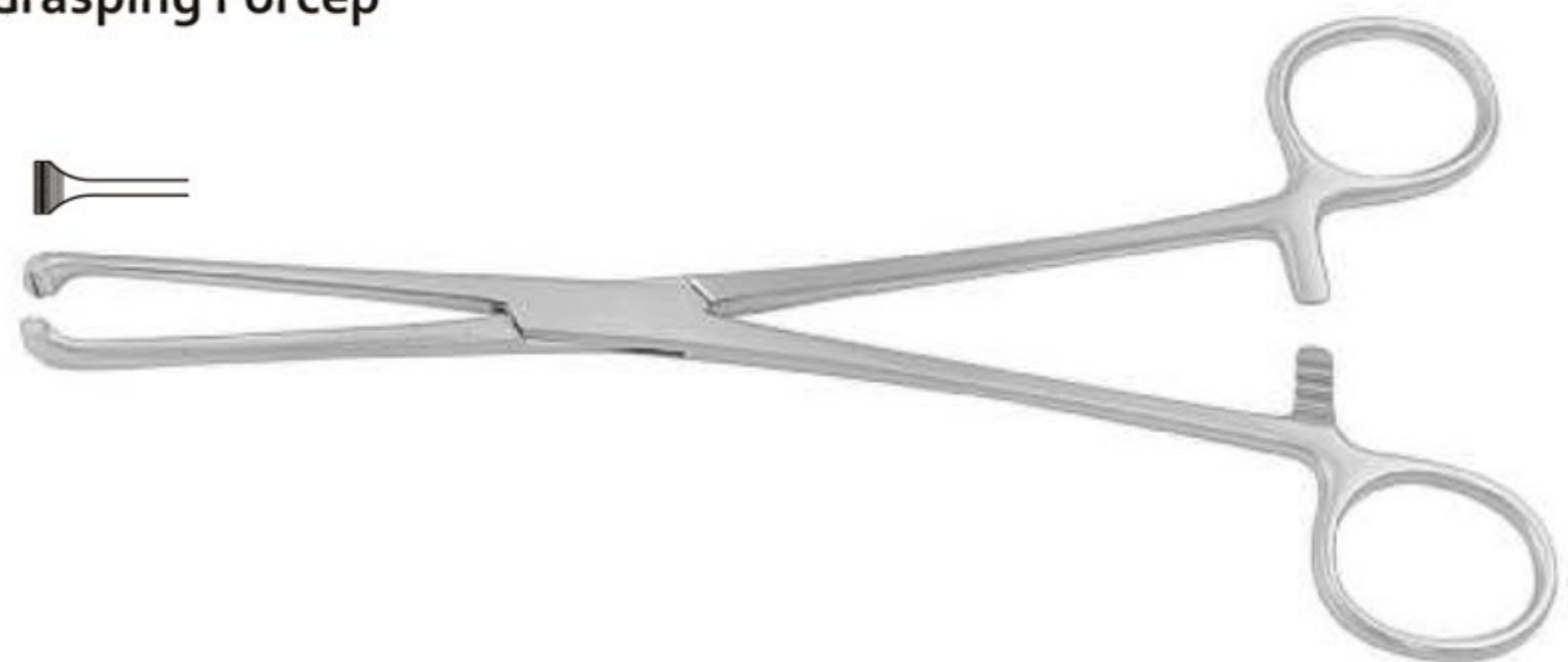

Allis-Adair Intestinal and Tissue Grasping Forcep

10 x 11 Teeth

Catalog #	Size
MT-SI-14-109	16 cm (6 1/4")





STOMACH INSTRUMENTS RECTUM

Intestinal and Tissue Grasping Forceps
Darm- und Gewebefasszangen
Pinzas para intestinos y tejidos
Pinces pour saisir intestins et tissus
Pinze per afferrare intestino e tessuti

Boys-Allis Intestinal and Tissue Grasping Forcep 5 x 6 Teeth

Catalog #	Size
MT-SI-14-110	15.5 cm (6")



Jud-Allis Intestinal and Tissue Grasping Forcep 3 x 4 Teeth

Catalog #	Size
MT-SI-14-111	15.5 cm (6")
MT-SI-14-112	19 cm (7 1/2")



Thoms-Allis Intestinal and Tissue Grasping Forcep 6 x 7 Teeth

Catalog #	Size
MT-SI-14-113	20.5 cm (8")



Allis Intestinal and Tissue Grasping Forcep 5 x 6 Teeth

Catalog #	Size
MT-SI-14-114	20 cm (8")



Lockwood Intestinal and Tissue Grasping Forcep

Catalog #	Size
MT-SI-14-115	20 cm (8")

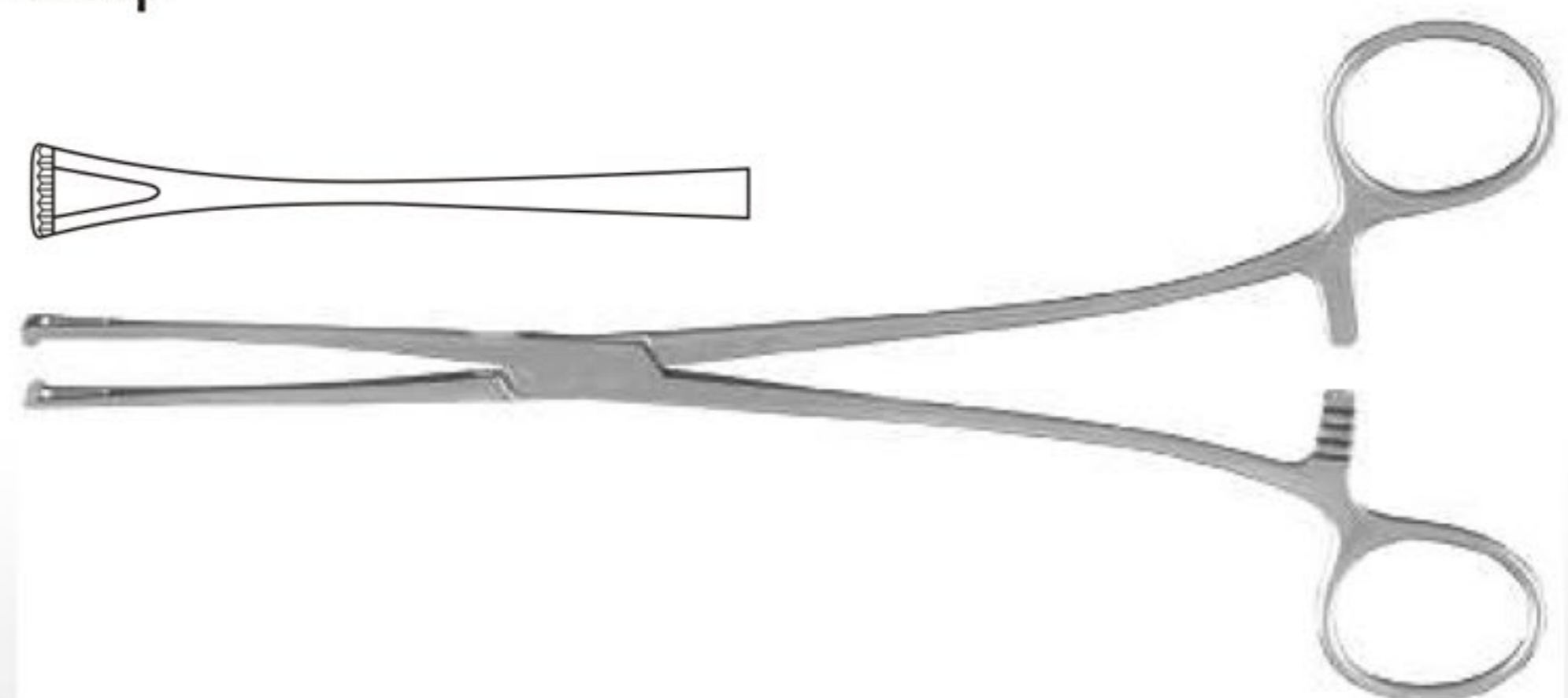



STOMACH INSTRUMENTS RECTUM

Intestinal and Tissue Grasping Forceps
Darm- und Gewebefasszangen
Pinzas para intestinos y tejidos
Pincas pour saisir intestins et tissus
Pinze per afferrare intestino e tessuti

Littlewood Intestinal and Tissue Grasping Forcep

Catalog #	Size
MT-SI-14-116	18.5 cm (7 1/4")



Williams Intestinal and Tissue Grasping Forcep

Catalog #	Size
MT-SI-14-117	16.5 cm (6 1/2")

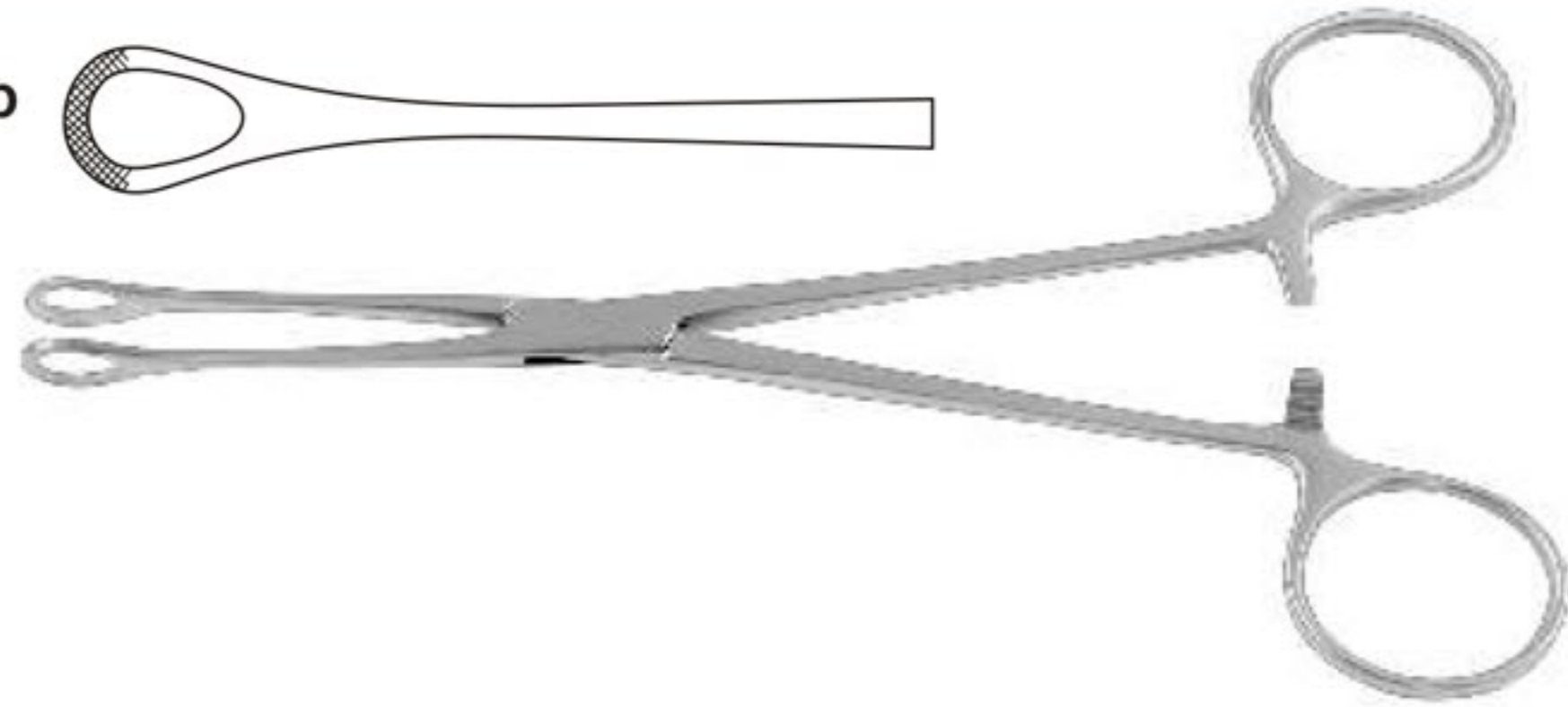

TC Babcock Intestinal and Tissue Grasping Forcep

Catalog #	Size
MT-SI-14-118	16.5 cm (6 1/2")
MT-SI-14-119	21 cm (8 1/4")

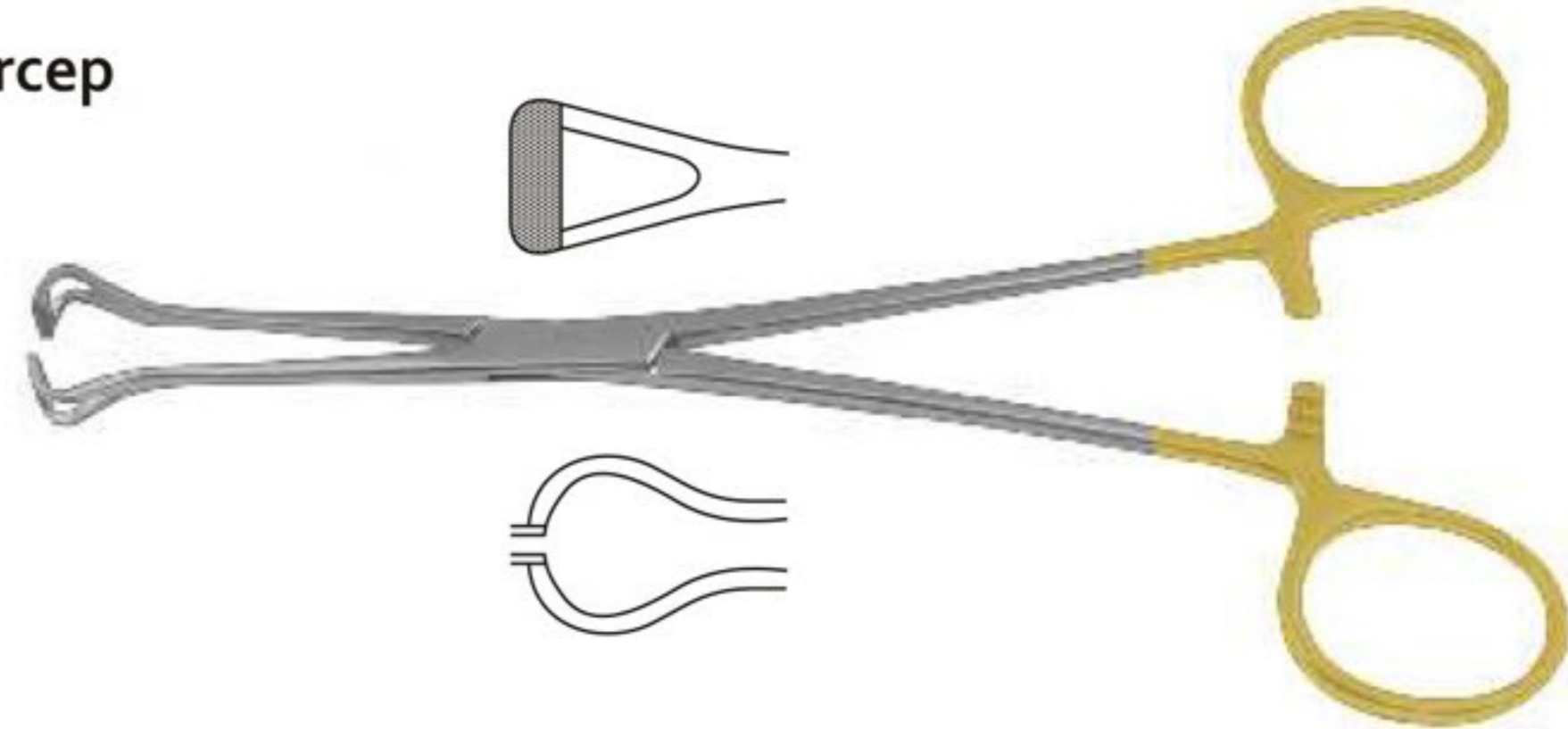

Babcock Intestinal and Tissue Grasping Forcep

Catalog #	Size
MT-SI-14-120	15.5 cm (6")
MT-SI-14-121	17.5 cm (7")
MT-SI-14-122	21 cm (8 1/4")
MT-SI-14-123	24 cm (9 1/2")

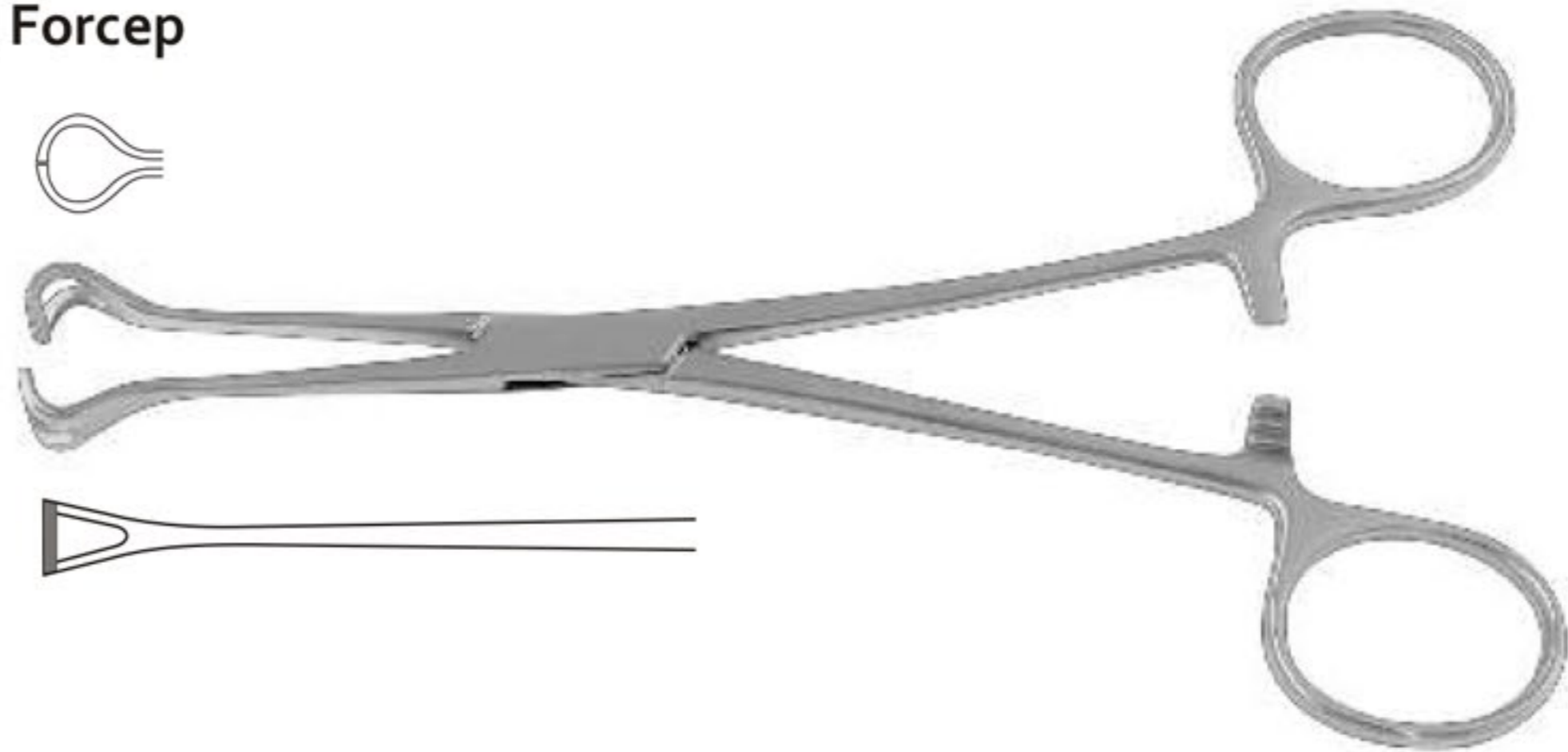

Babcock Atrauma Intestinal and Tissue Grasping Forcep

Catalog #	Size
MT-SI-14-124	16 cm (6 1/4")
MT-SI-14-125	20.5 cm (8")





STOMACH INSTRUMENTS RECTUM

Intestinal and Tissue Grasping Forceps
Darm- und Gewebefasszangen
Pinzas para intestinos y tejidos
Pinces pour saisir intestins et tissus
Pinze per afferrare intestino e tessuti

TC Duval Intestinal and Tissue Grasping Forcep

Catalog #	Size
MT-SI-14-126	20.5 cm (8")

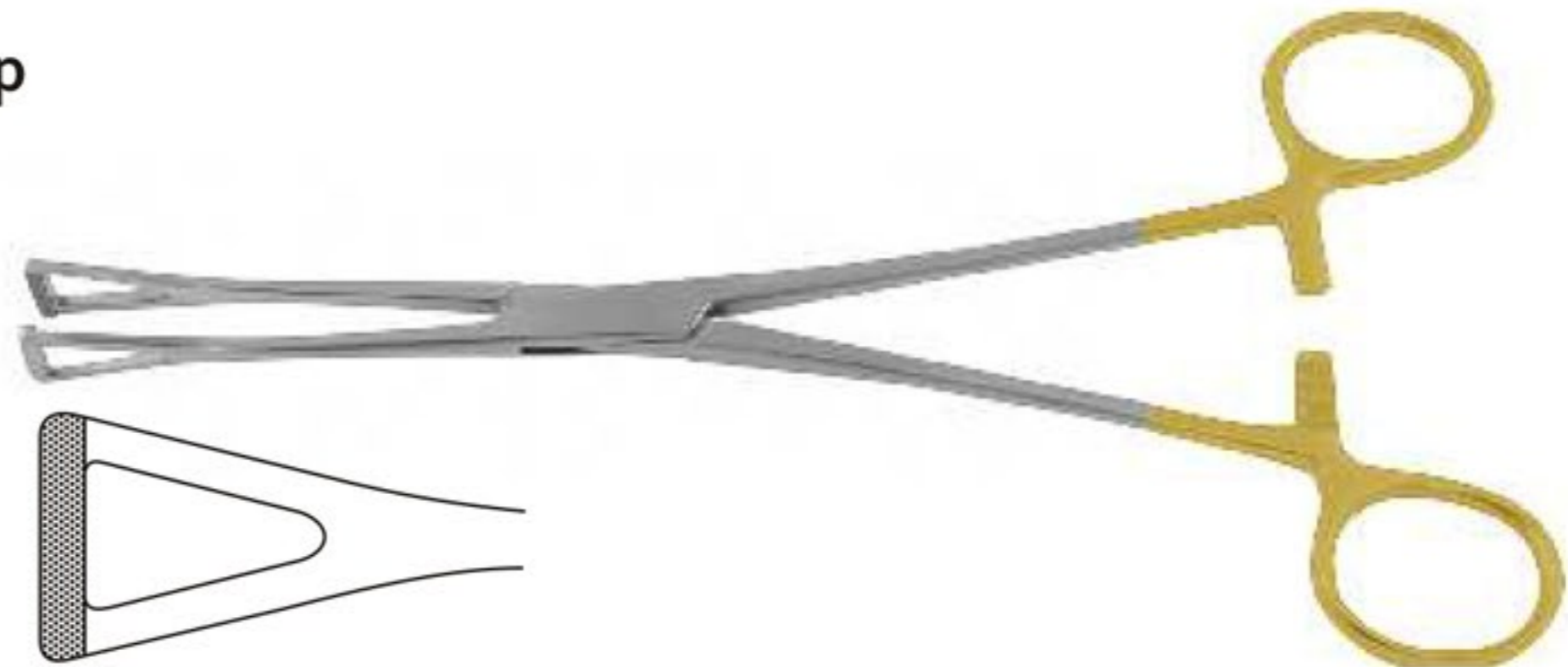

Duval Intestinal and Tissue Grasping Forcep Narrow Jaw

Catalog #	Size
MT-SI-14-127	18 cm (7")
MT-SI-14-128	20.5 cm (8")

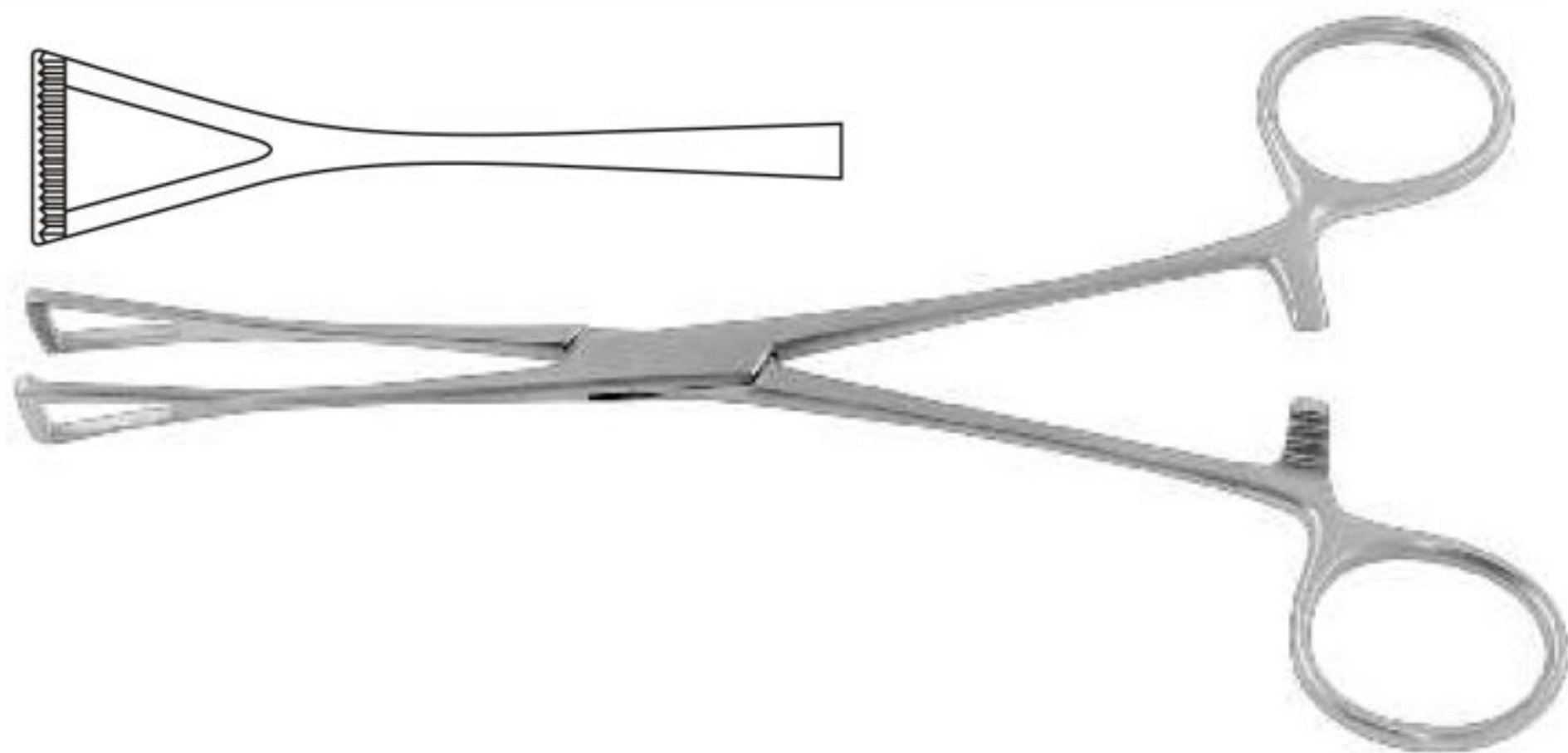

Duval Intestinal and Tissue Grasping Forcep Wide Jaw

Catalog #	Size
MT-SI-14-129	20.5 cm (8")
MT-SI-14-130	23 cm (9")

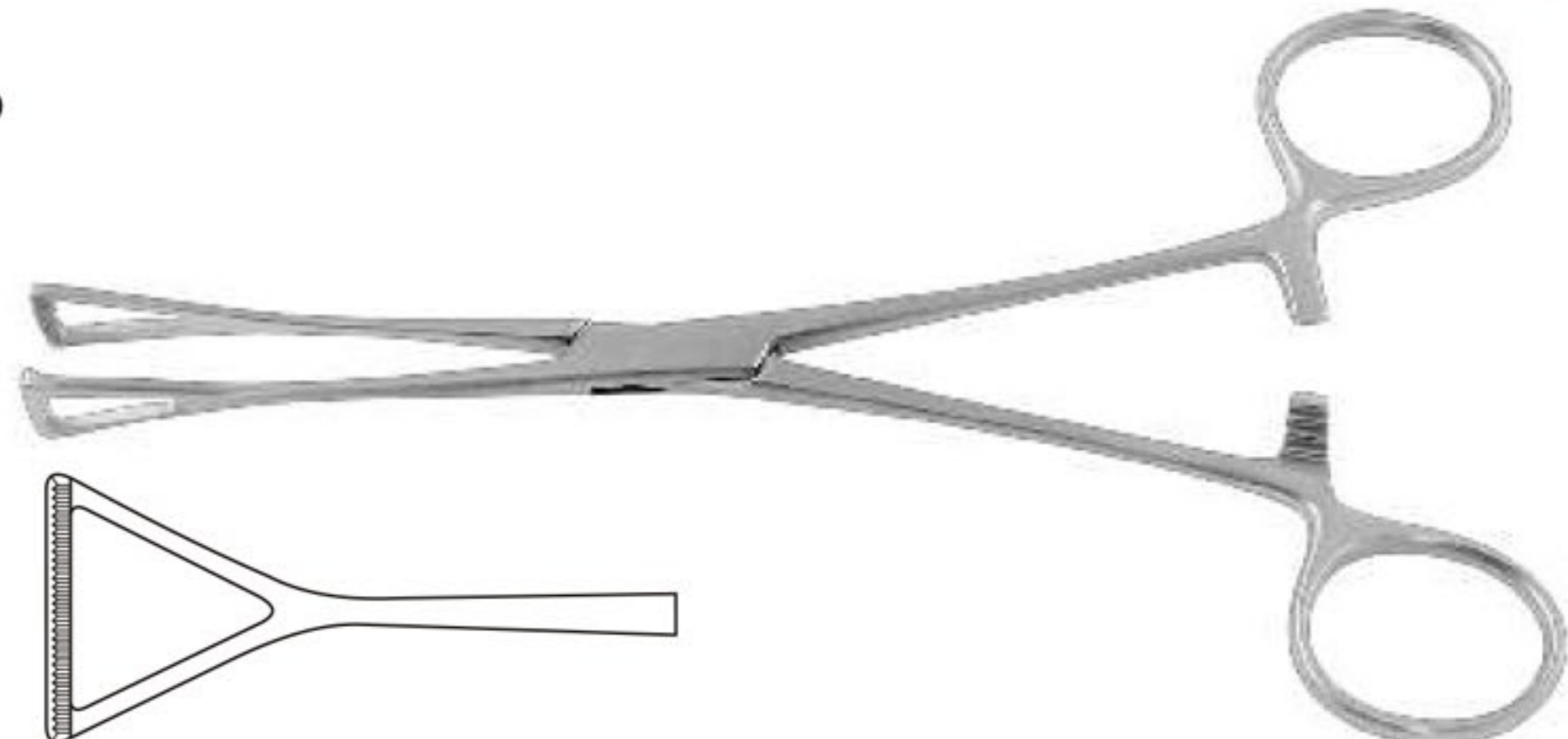

Doyen-Baby Intestinal Clamp Straight

Catalog #	Size
MT-SI-14-131	18 cm (7")



Doyen-Baby Intestinal Clamp Curved

Catalog #	Size
MT-SI-14-132	17.5 cm (7")





STOMAC INSTRUMENTS RECTUM

Intestinal Clamps
Darmklemmen
Pinzas intestinales
Pinces intestinales
Pinze intestinali

Doyen Intestinal Clamp

Straight

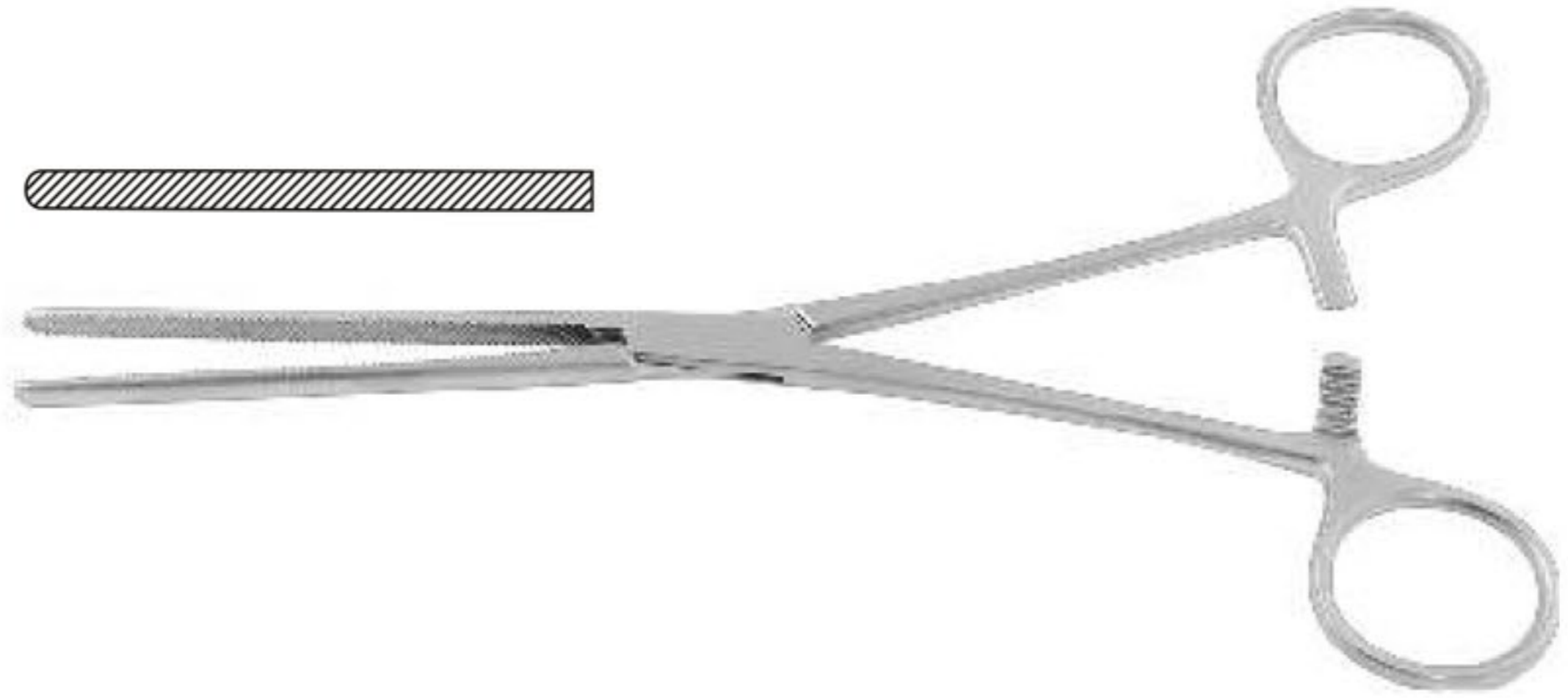

Catalog #	Size
MT-SI-14-133	21.5 cm (8 1/2")
MT-SI-14-134	23.5 cm (9 1/4")

Doyen Intestinal Clamp

Curved

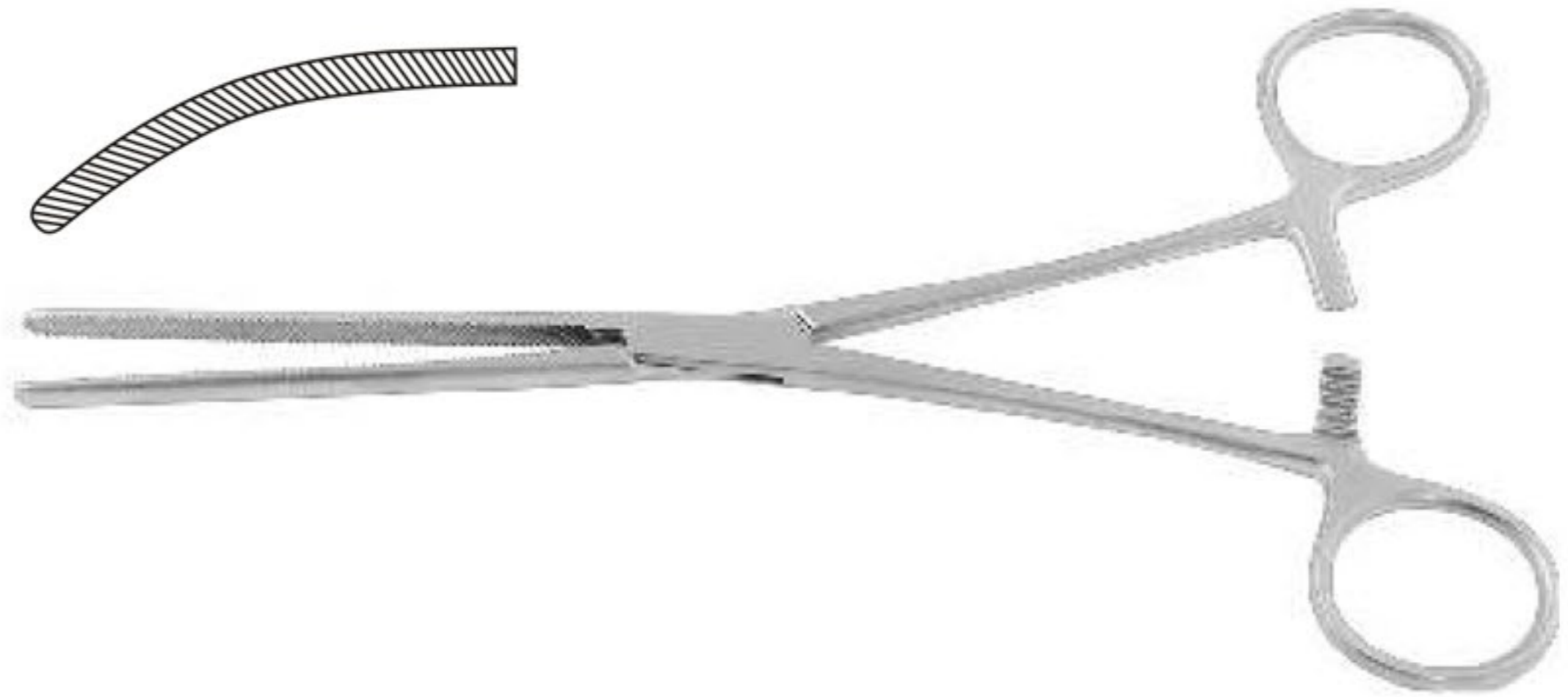

Catalog #	Size
MT-SI-14-135	21.5 cm (8 1/2")
MT-SI-14-136	23 cm (9")

Mayo-Robson Intestinal Clamp

Straight

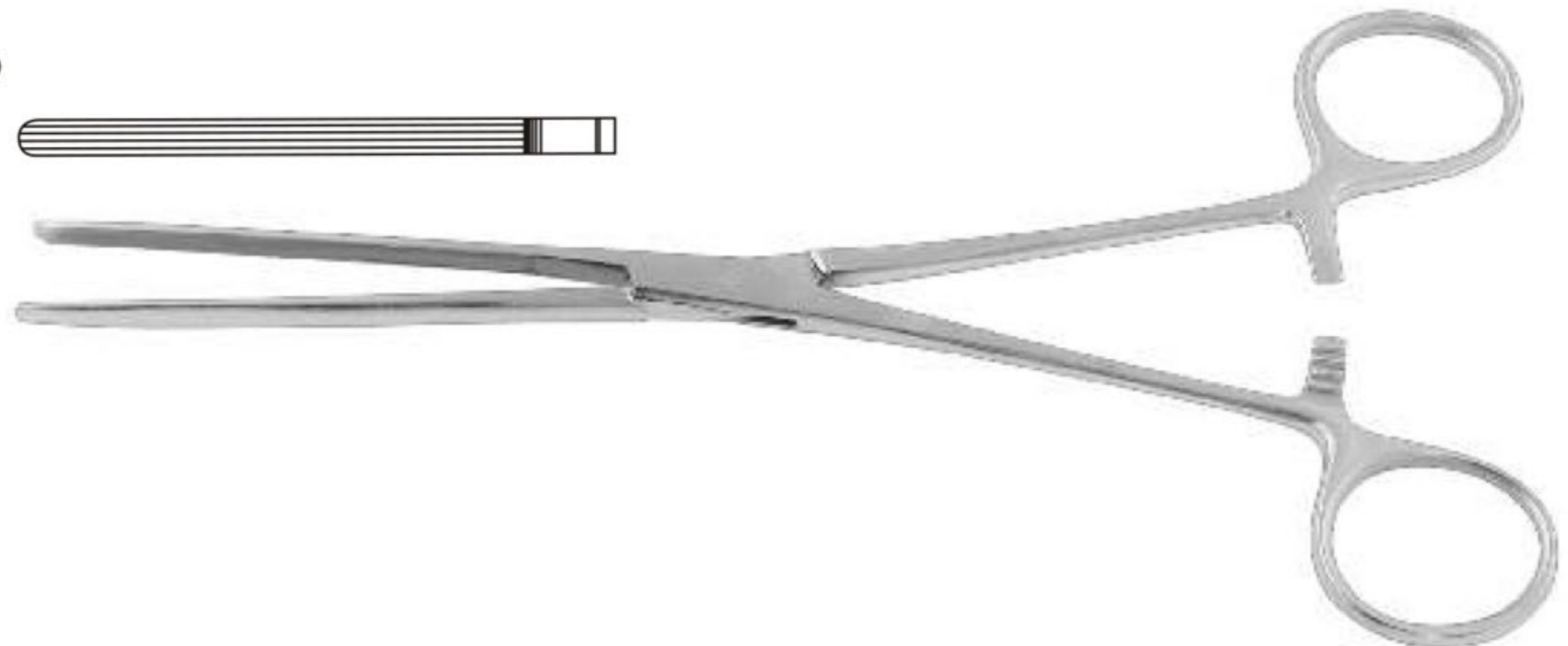

Catalog #	Size
MT-SI-14-137	21.5 cm (8 1/2")
MT-SI-14-138	23.5 cm (9 1/4")
MT-SI-14-139	25.5 cm (10")

Mayo-Robson Intestinal Clamp

Curved

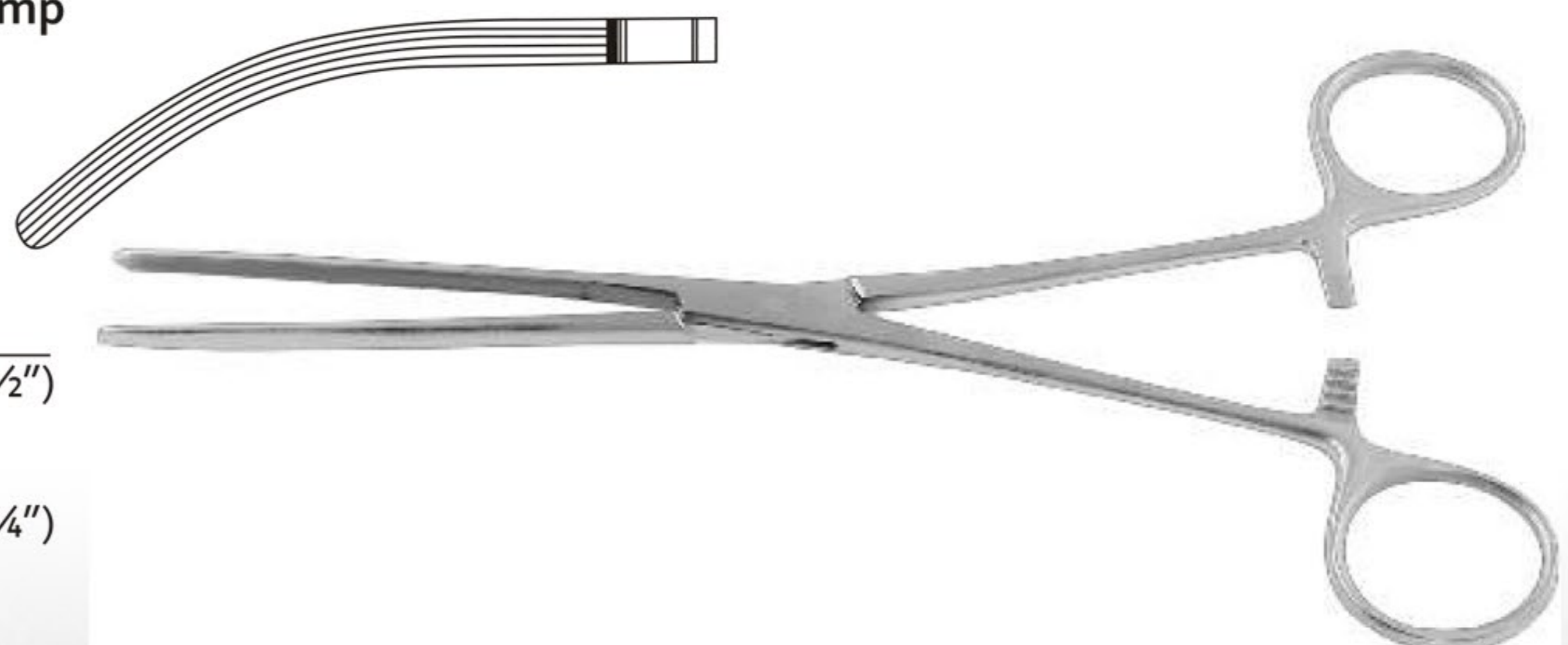

Catalog #	Size
MT-SI-14-140	21.5 cm (8 1/2")
MT-SI-14-141	23 cm (9")
MT-SI-14-142	24.5 cm (9 3/4")



STOMACH INSTRUMENTS RECTUM

Intestinal Clamps
Darmklemmen
Pinzas intestinales
Pincas intestinales
Pinze intestinali

Kocher-Baby Intestinal Clamp Straight

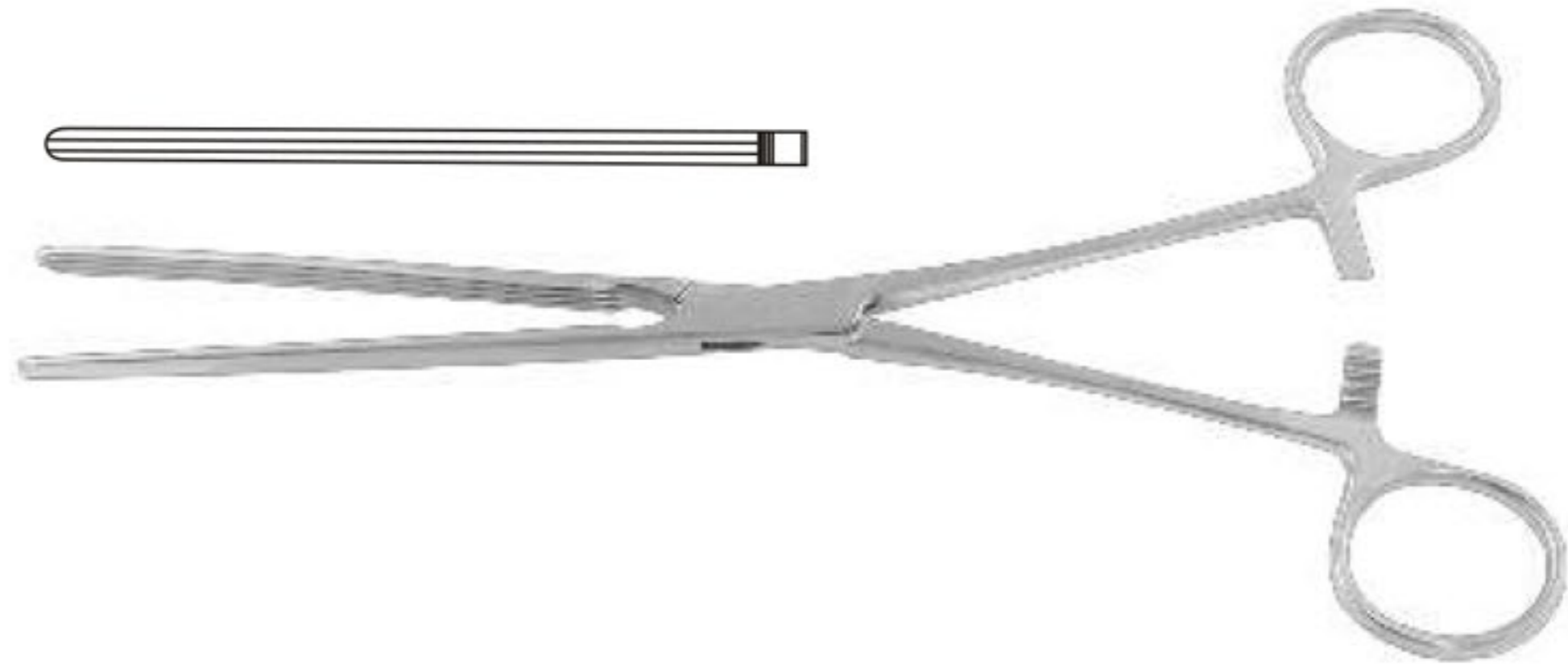

Catalog #	Size
MT-SI-14-143	13 cm (5")

Kocher-Baby Intestinal Clamp Curved

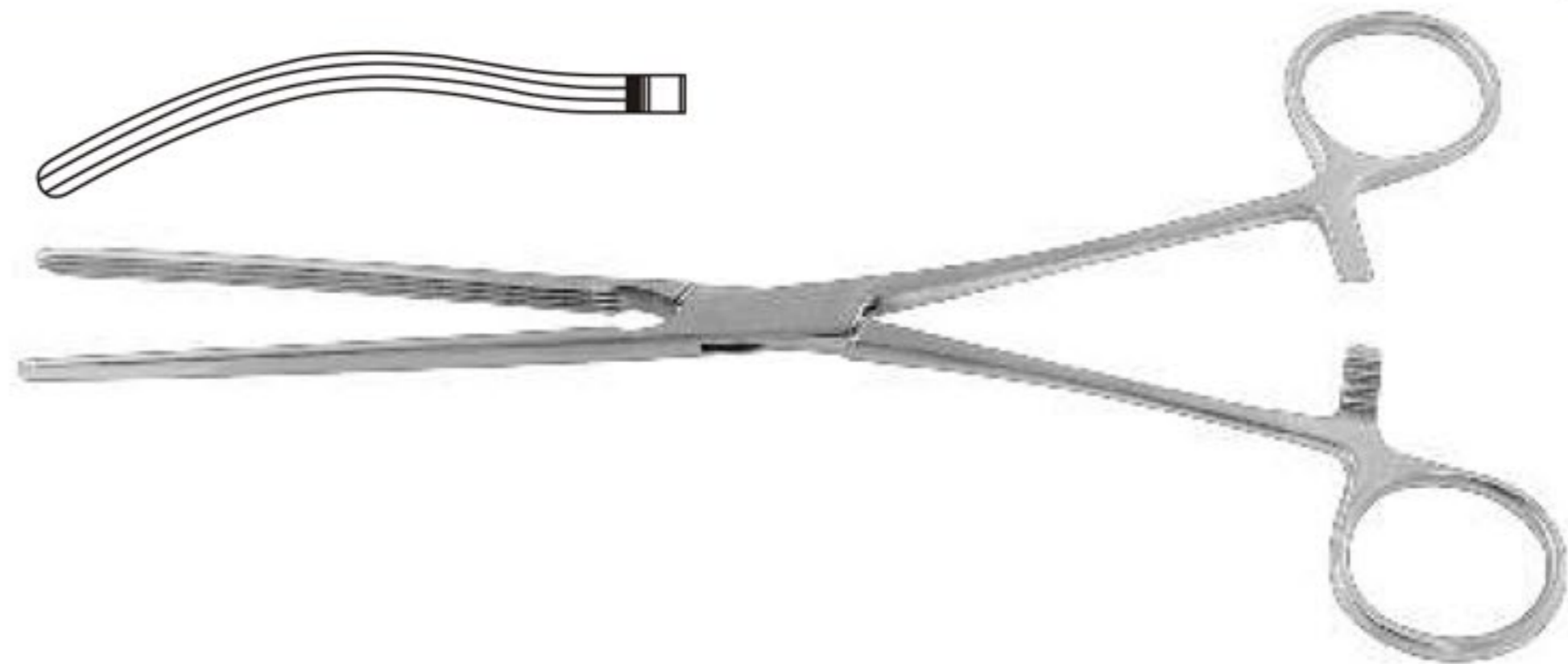

Catalog #	Size
MT-SI-14-144	13 cm (5")

Kocher Intestinal Clamp Straight

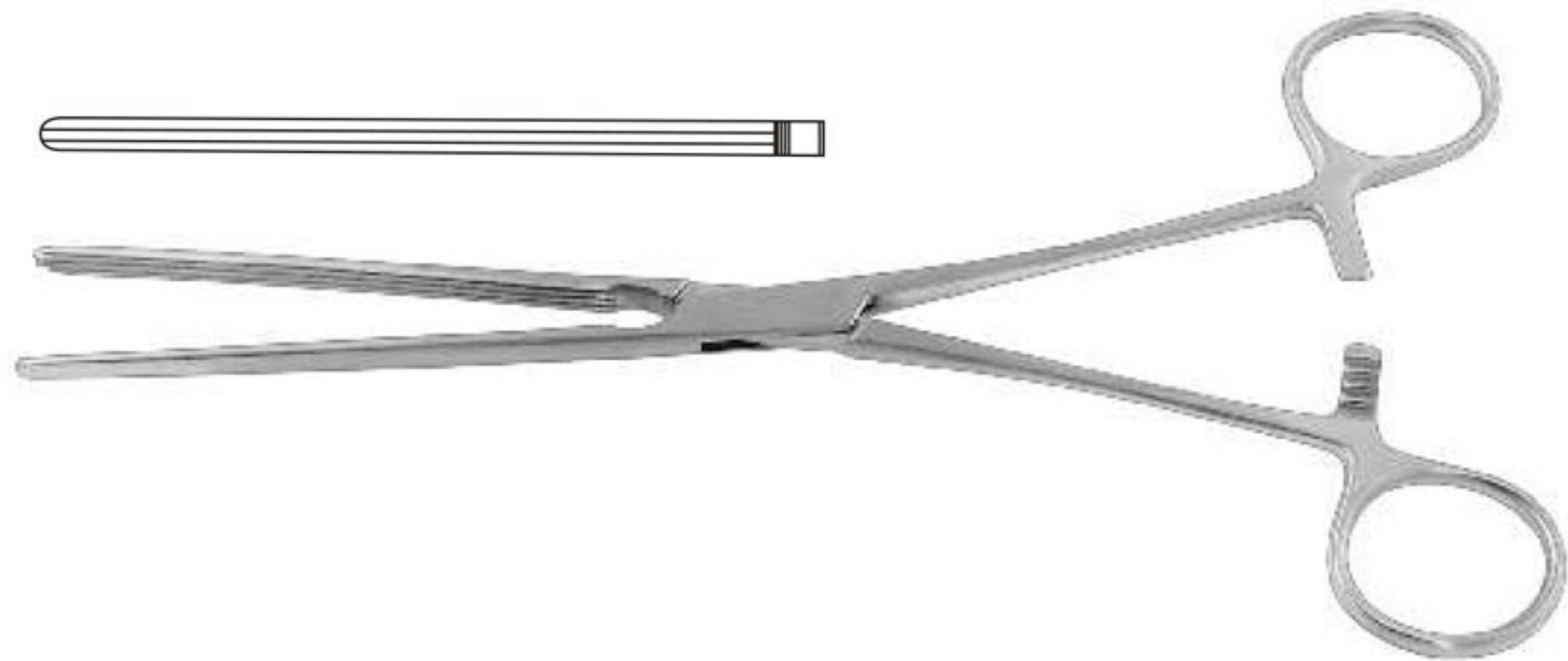

Catalog #	Size
MT-SI-14-145	22.5 cm (8 3/4")
MT-SI-14-146	25 cm (9 3/4")
MT-SI-14-147	28.5 cm (11 1/4")

Kocher Intestinal Clamp Curved

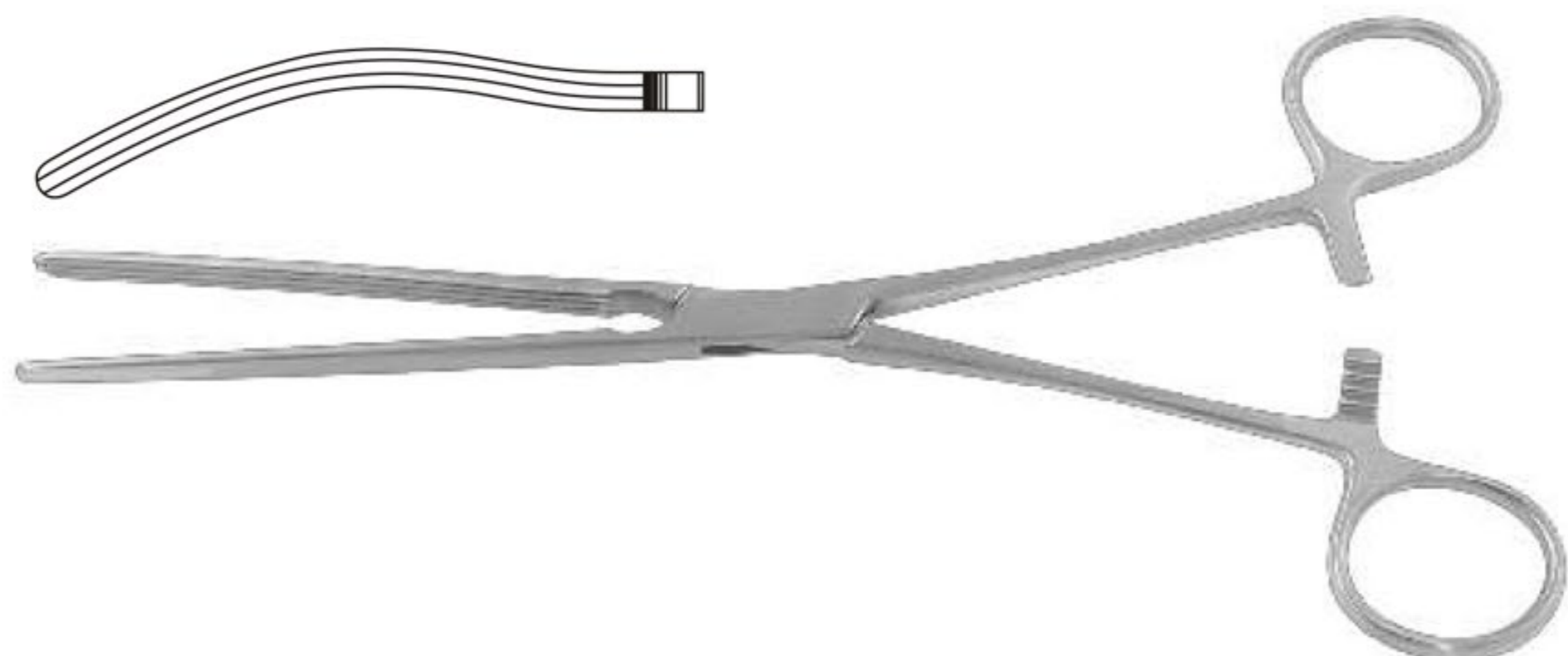

Catalog #	Size
MT-SI-14-148	22.5 cm (8 3/4")
MT-SI-14-149	24.5 cm (9 3/4")
MT-SI-14-150	27.5 cm (10 3/4")

Allen Intestinal Clamp

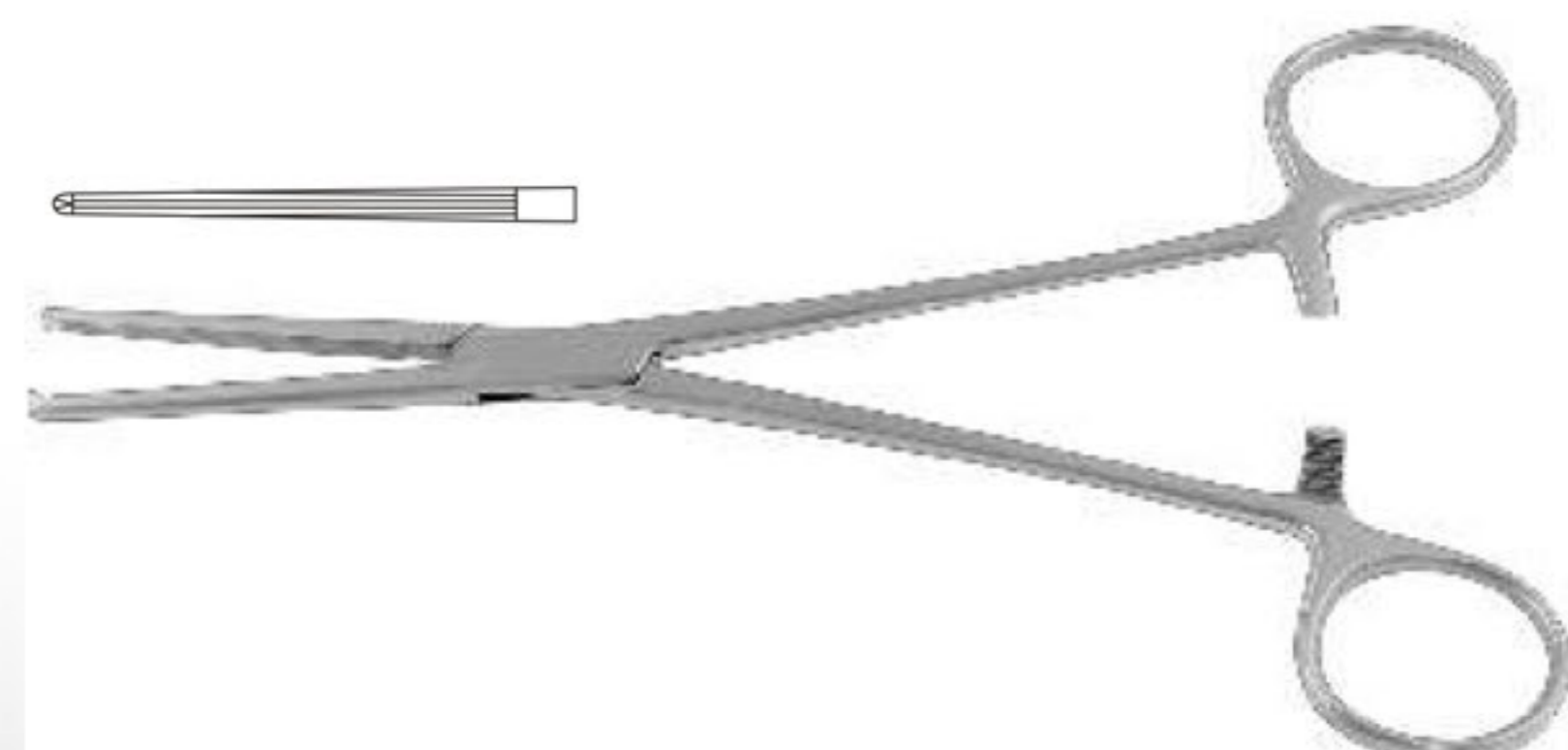

Catalog #	Size
MT-SI-14-151	16 cm (6 1/4")



STOMAC INSTRUMENTS RECTUM

Intestinal Clamps
Darmklemmen
Pinzas intestinales
Pincas intestinales
Pinze intestinali

Payr-Baby Intestinal Clamp

Catalog #	Size
MT-SI-14-152	15 cm (6")

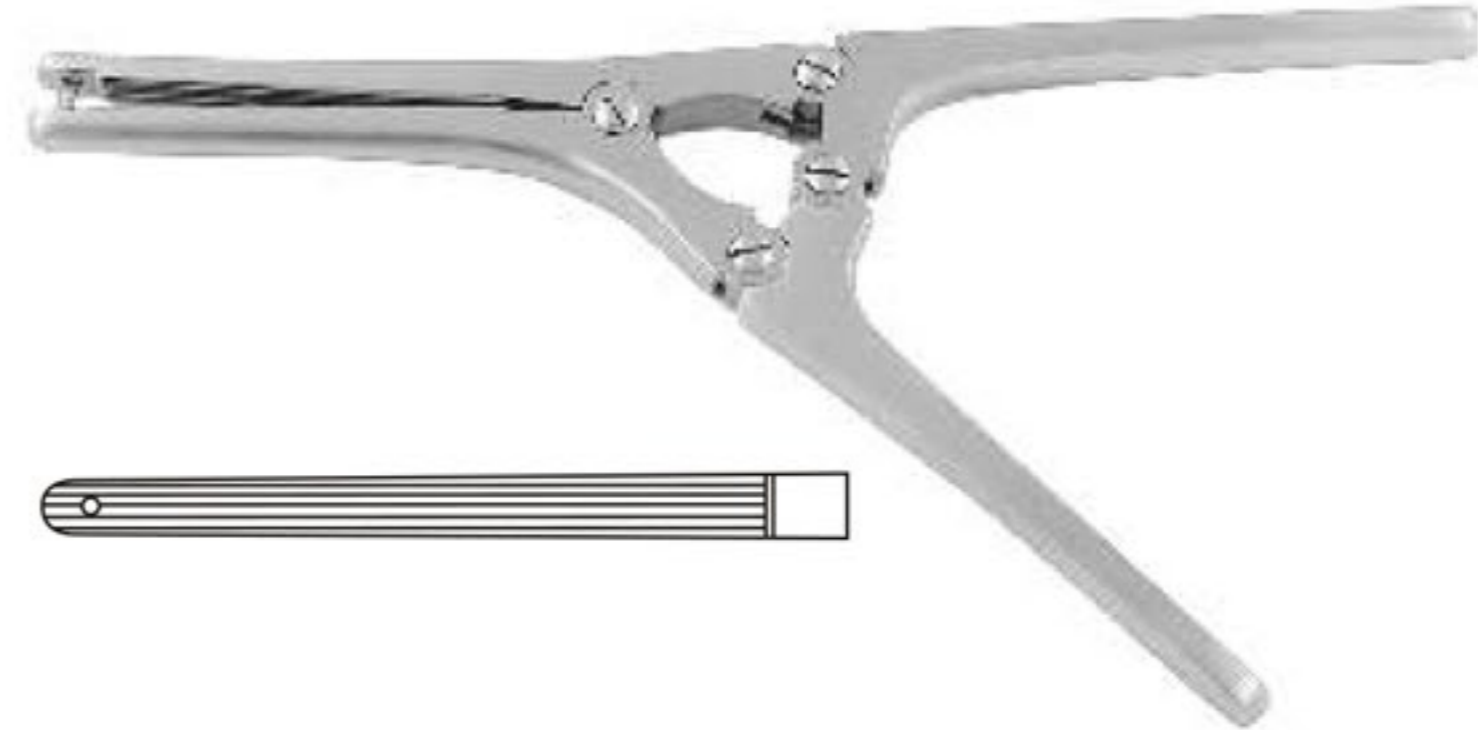

Payr Intestinal Clamp

Catalog #	Size
MT-SI-14-153	20.5 cm (8")
MT-SI-14-154	29 cm (11 1/2")
MT-SI-14-155	34.5 cm (13 1/2")

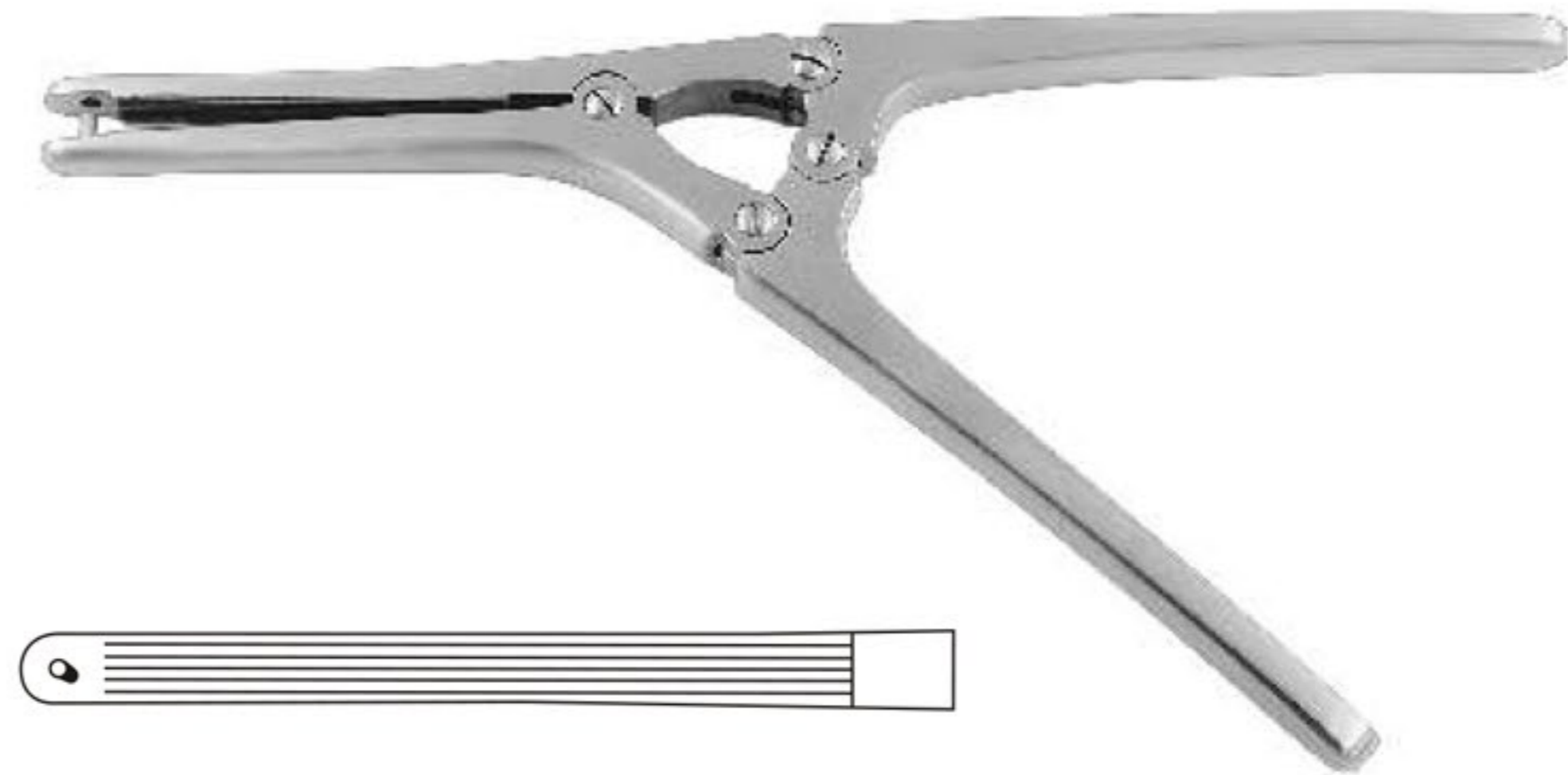

Nussbaum Intestinal Clamp Straight

Catalog #	Size
MT-SI-14-156	25 cm (9 3/4")

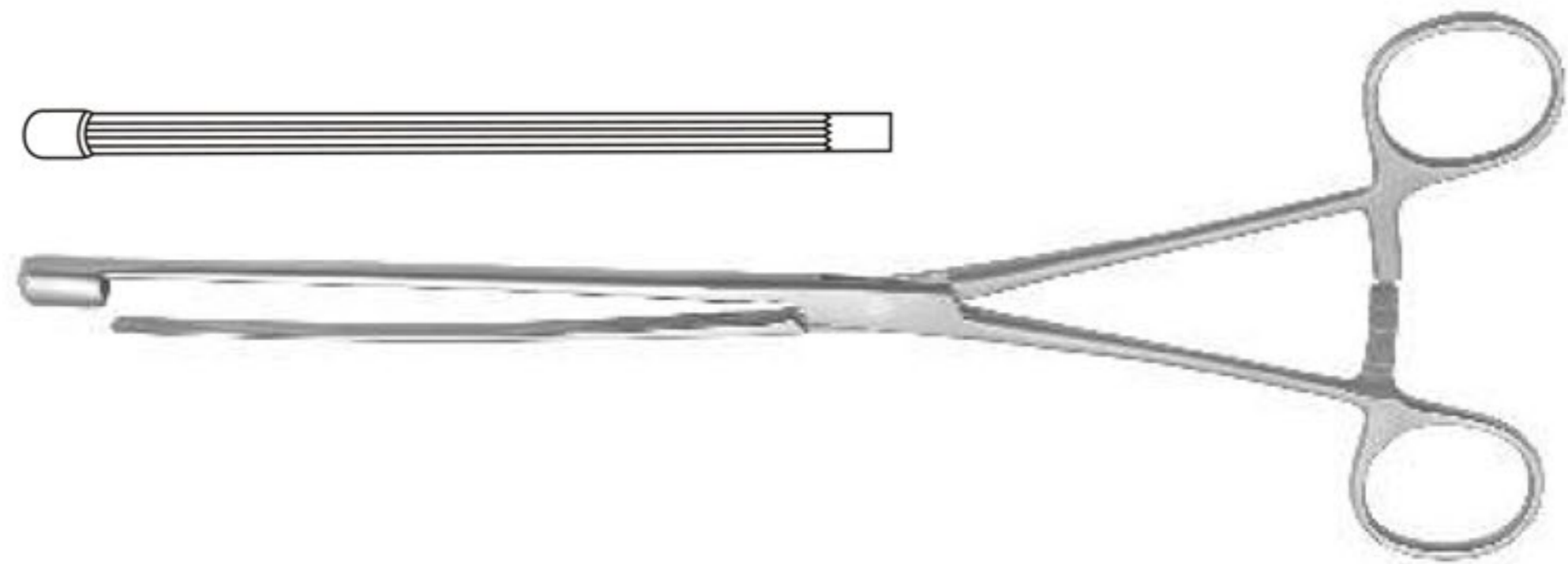

Nussbaum Intestinal Clamp Curved

Catalog #	Size
MT-SI-14-157	25 cm (9 3/4")

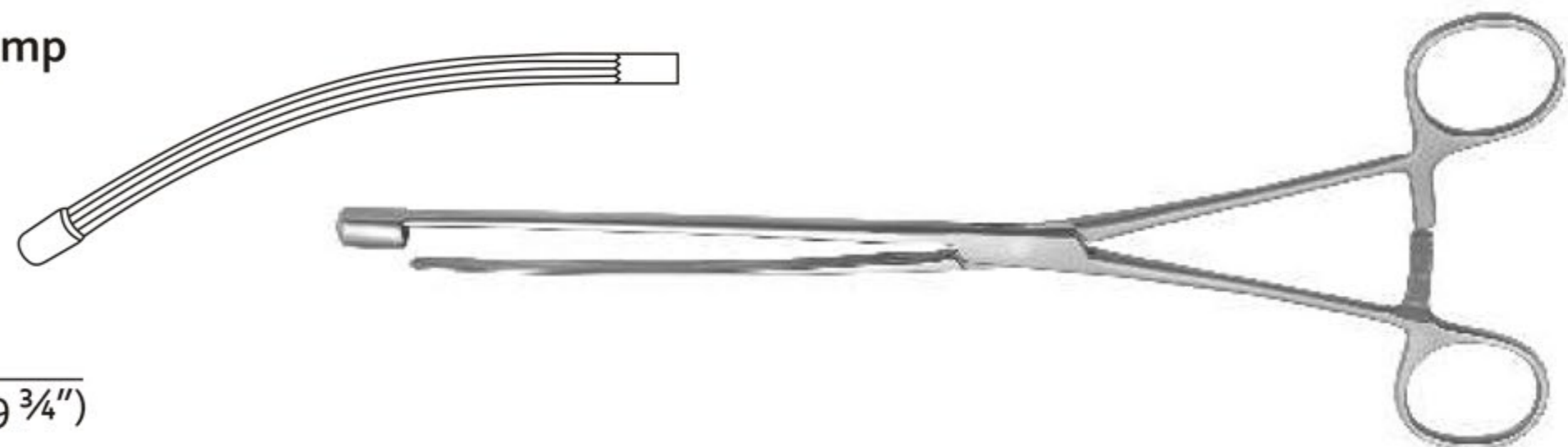

Lane Intestinal Clamp Straight

Catalog #	Size
MT-SI-14-158	30 cm (11 3/4")

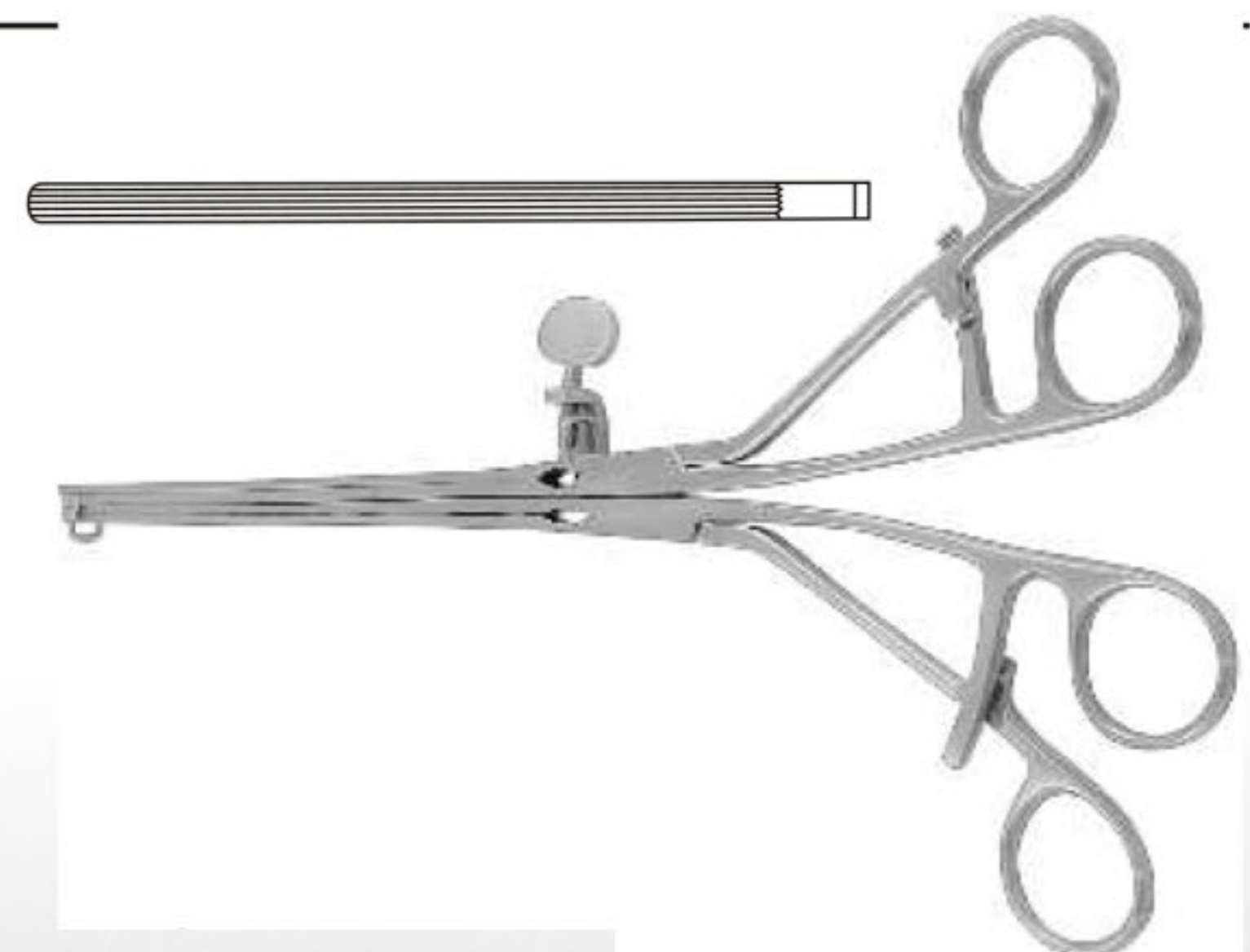



STOMACH INSTRUMENTS RECTUM

Darmklemmen
Pinzas intestinales
Pincas intestinales
Pinze intestinali

Lane Intestinal Clamp

Curved

Catalog #	Size
MT-SI-14-159	30 cm (11 3/4")

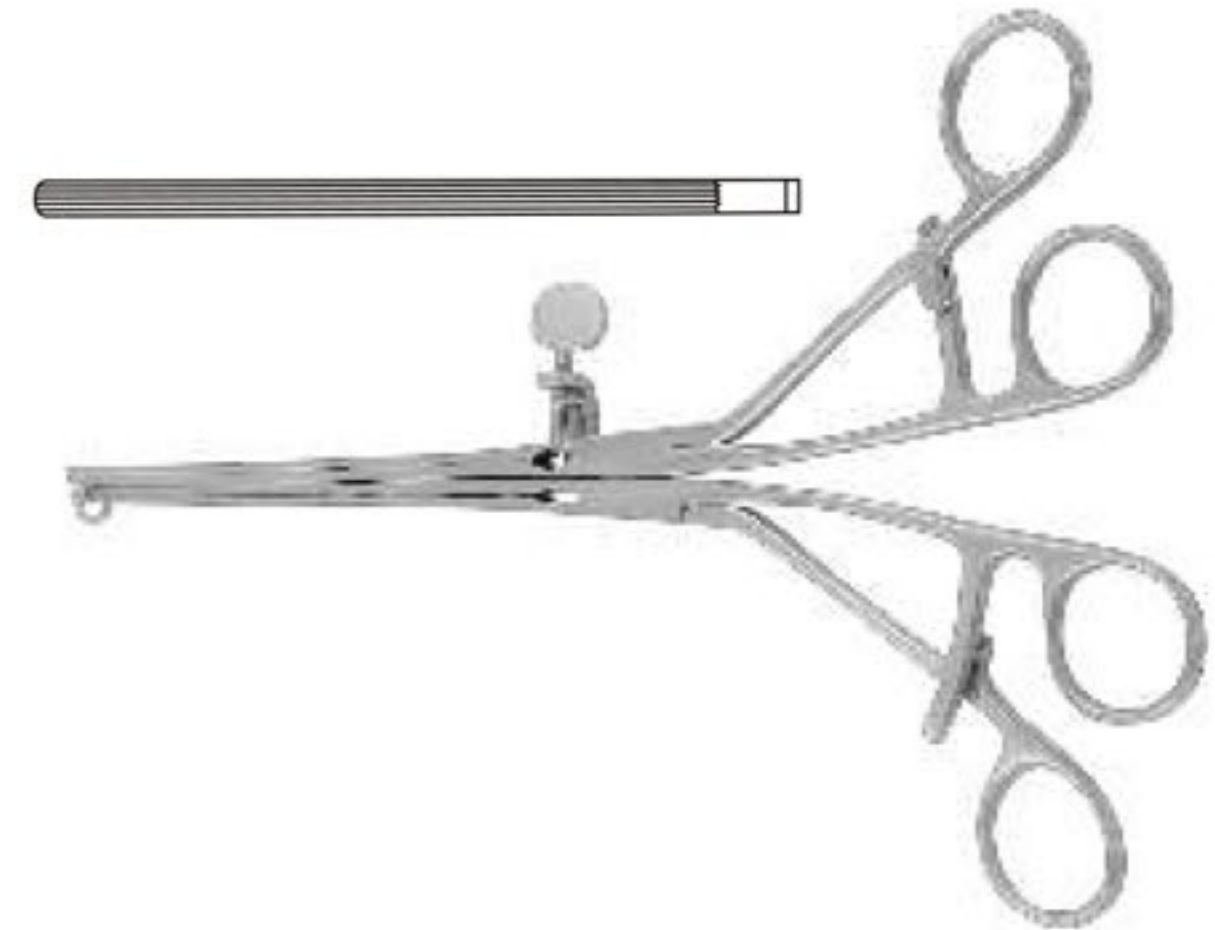

Haberer Intestinal Clamp

Catalog #	Size
MT-SI-14-160	36 cm (14 1/4")

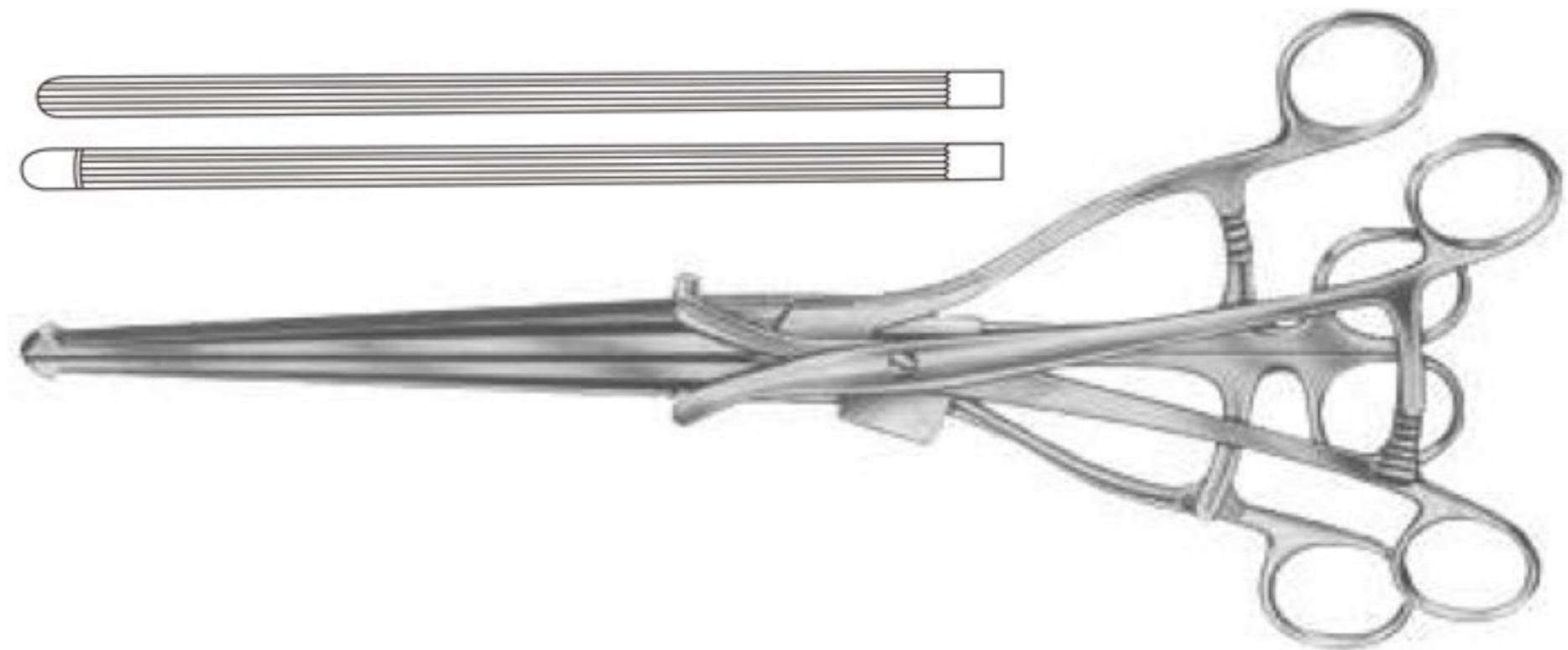

Scudder Intestinal Clamp

Straight

Catalog #	Size
MT-SI-14-161	33.5 cm (13 1/4")

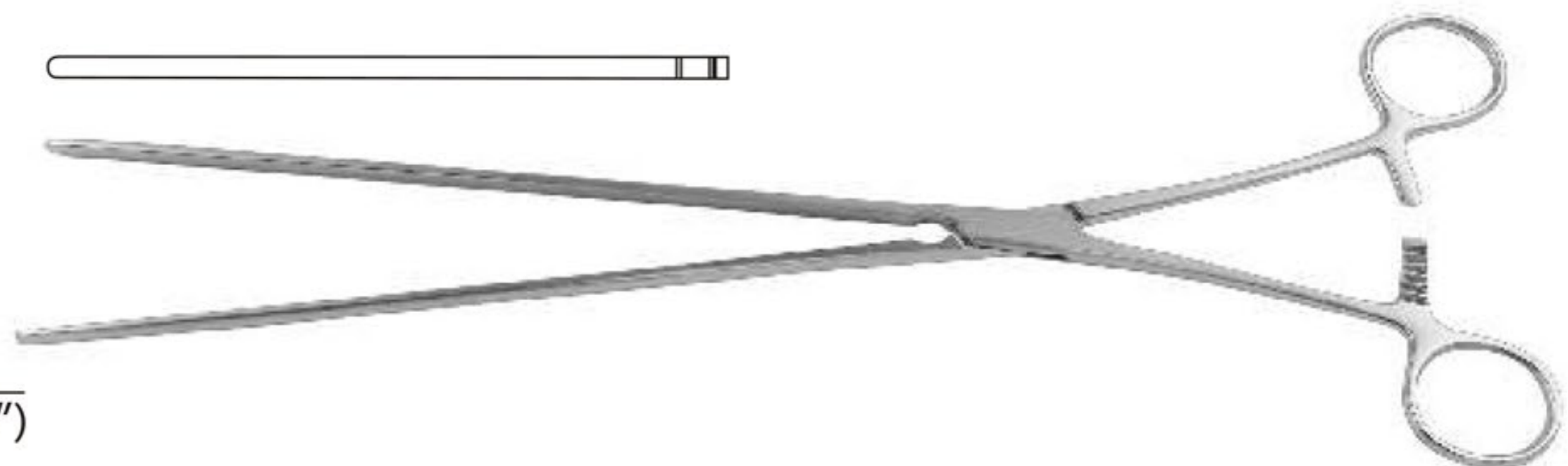

Scudder Intestinal Clamp

Curved

Catalog #	Size
MT-SI-14-162	32.5 cm (12 3/4")

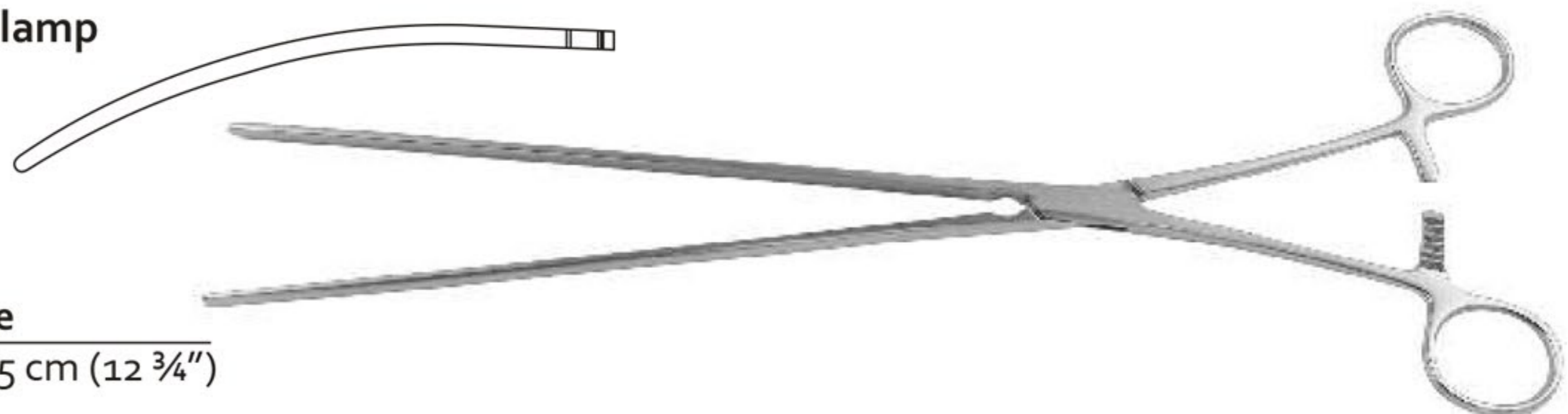

Brunner Atrauma Sigmoid Anastomosis Clamp

Catalog #	Size
MT-SI-14-163	24 cm - 9 1/2"

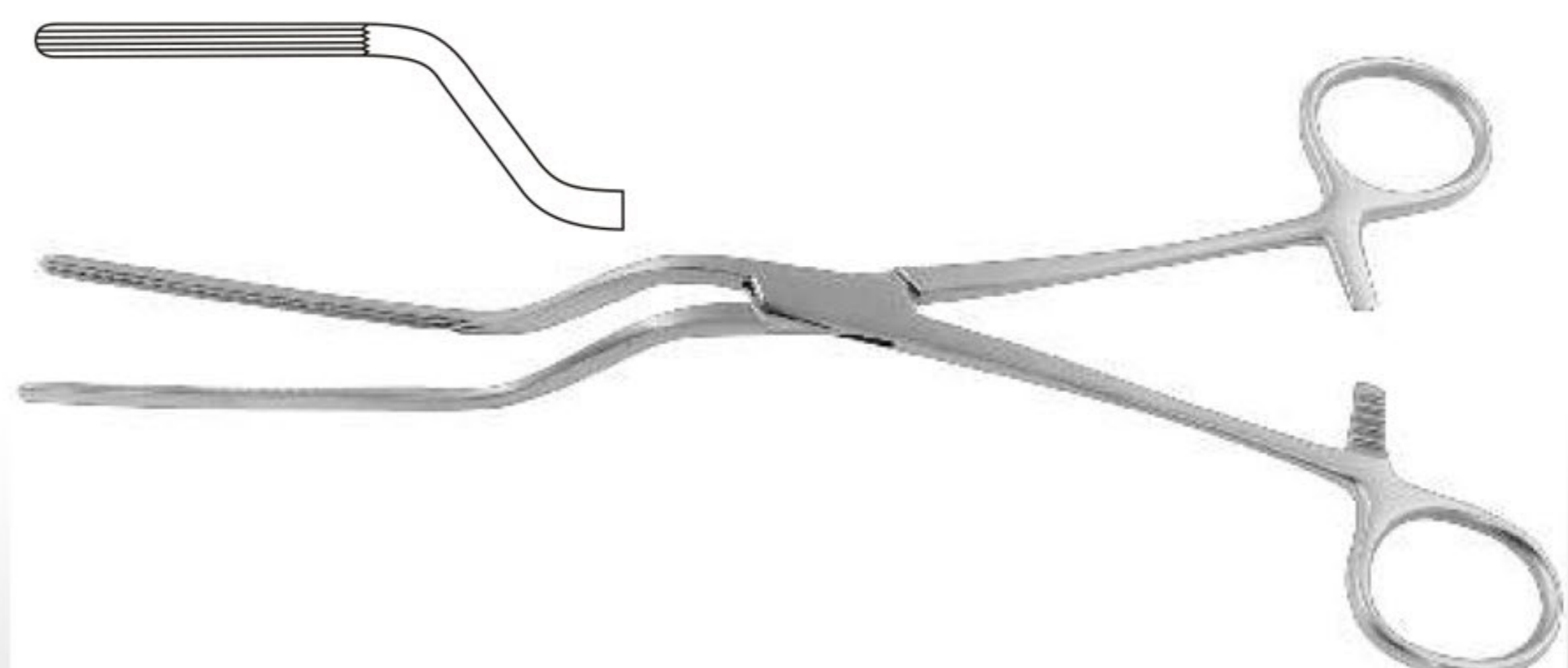



STOMAC INSTRUMENTS RECTUM

Intestinal Clamps
Darmklemmen
Pinzas intestinales
Pincas intestinales
Pinze intestinali

De Martel-Wolfson Intestinal Anastomosis Clamp

Set of 3 Ref: SI-172-01 to SI-172-03

Catalog #	Size
MT-SI-14-164	N/A

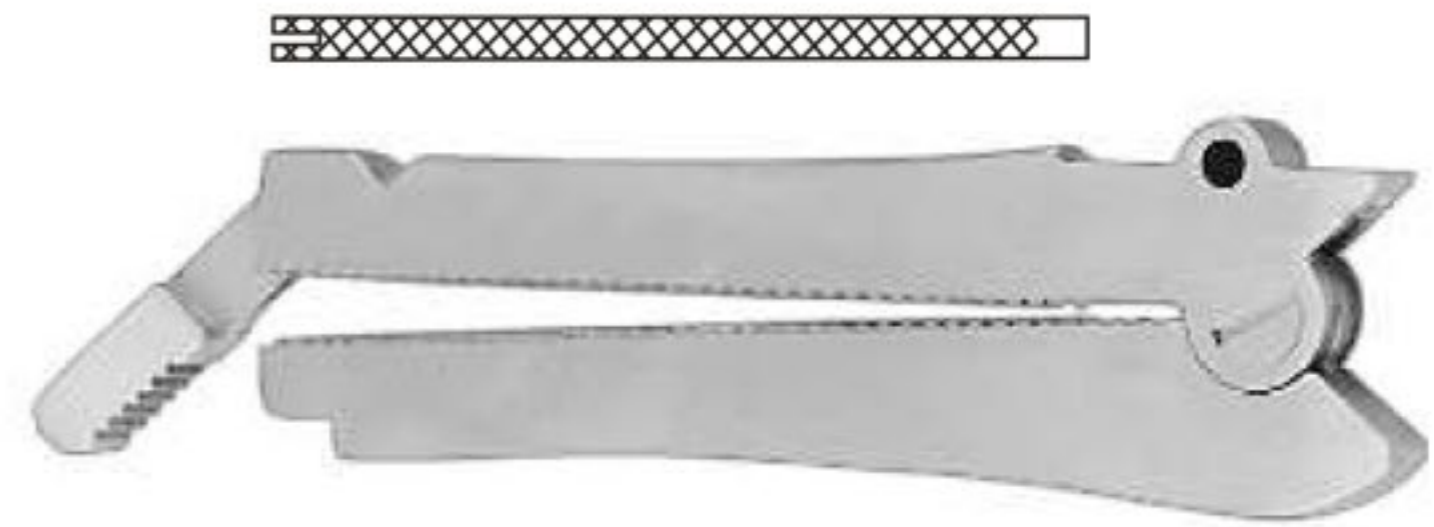

De Martel-Wolfson Intestinal Anastomosis Clamp

Catalog #	Jaw Length
MT-SI-14-165	65 mm
MT-SI-14-166	80 mm
MT-SI-14-167	110 mm

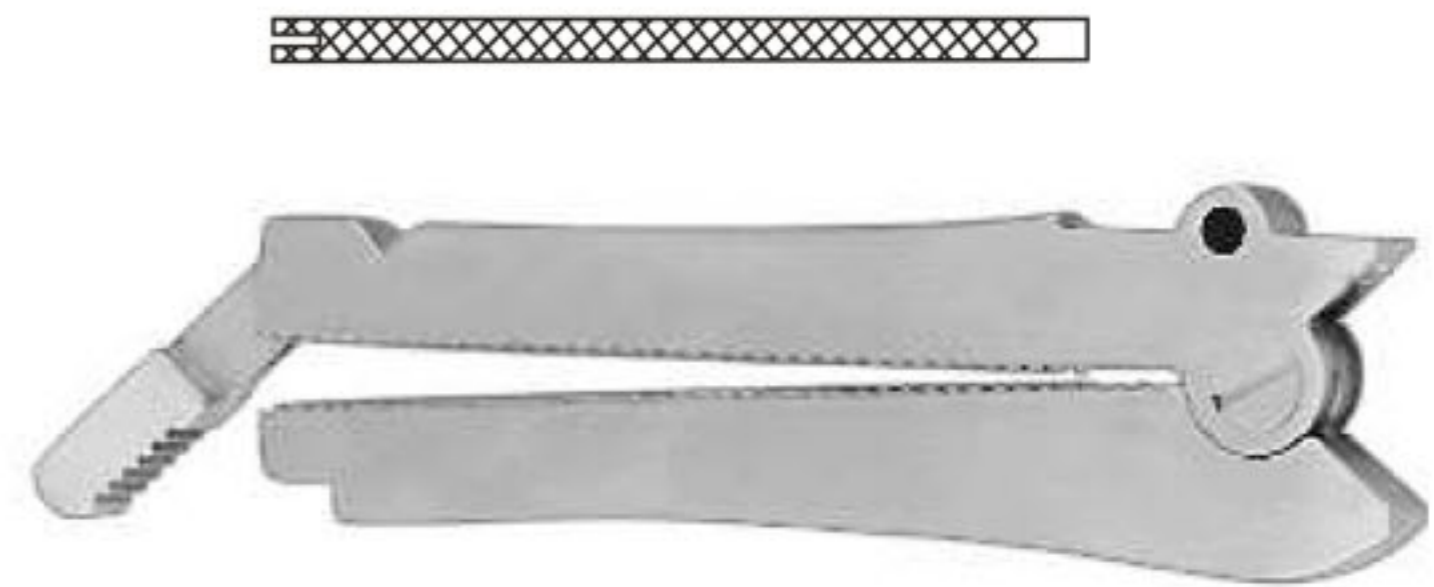

De Martel-Wolfson Closing Forcep

Catalog #	Size
MT-SI-14-168	25 cm (9 3/4")



De Martel-Wolfson Clamp Holder

Catalog #	Size
MT-SI-14-169	9.5 cm (3 3/4")
MT-SI-14-170	23 cm (9")



Benson Pylorus Spreader

Catalog #	Size
MT-SI-14-171	15.5 cm (6")





STOMACH INSTRUMENTS RECTUM

Intestinal Clamps
Darmklemmen
Pinzas intestinales
Pinces intestinales
Pinze intestinali

Scheibe (Collin) Atrauma Organ Grasping

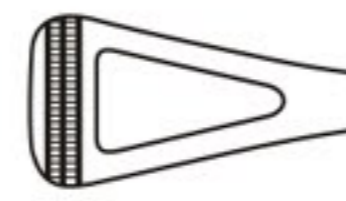

Catalog #	Size, Profile
MT-SI-14-172	18 cm (7"), Narrow Jaw
MT-SI-14-173	20.5 cm (8"), Medium Jaw
MT-SI-14-174	23 cm (8"), Wide Jaw

Doyen-Baby Atrauma Intestinal Clamp

Straight

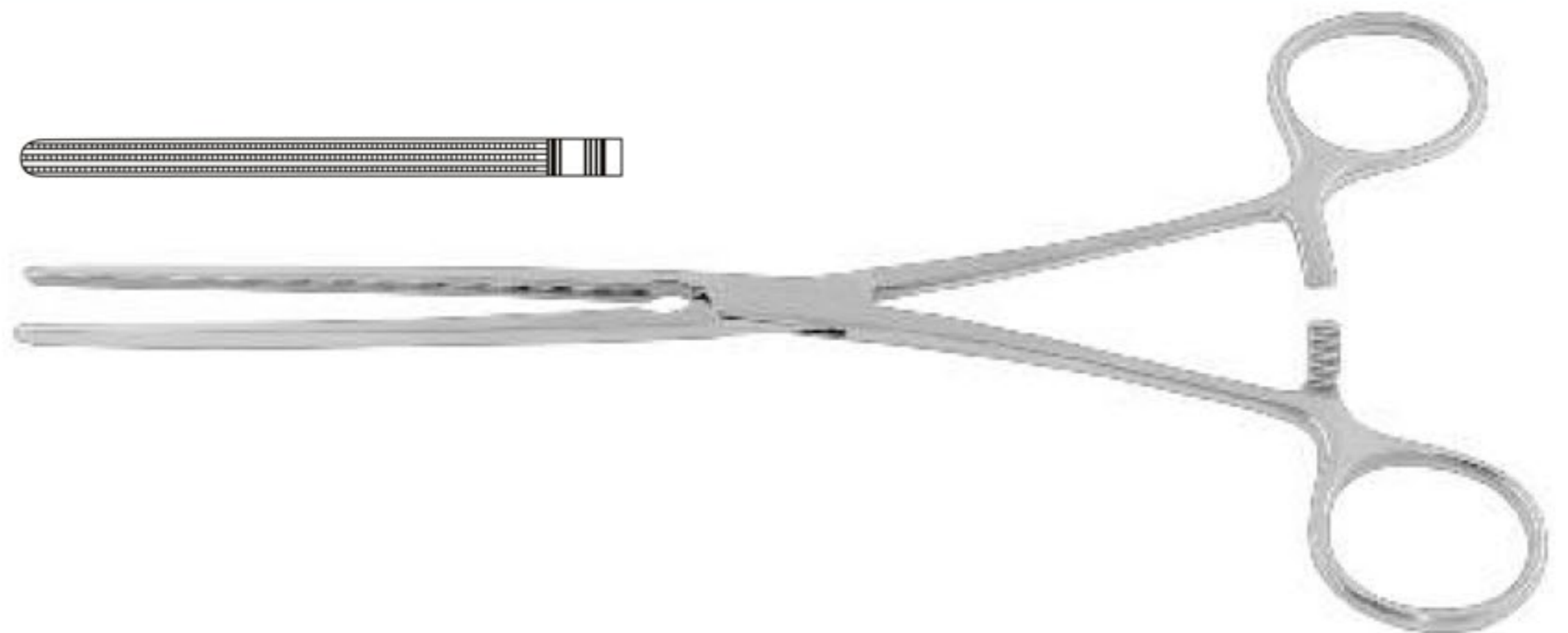
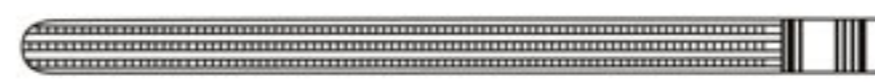

Catalog #	Size
MT-SI-14-175	14 cm (5")

Doyen-Baby Atrauma Intestinal Clamp

Curved

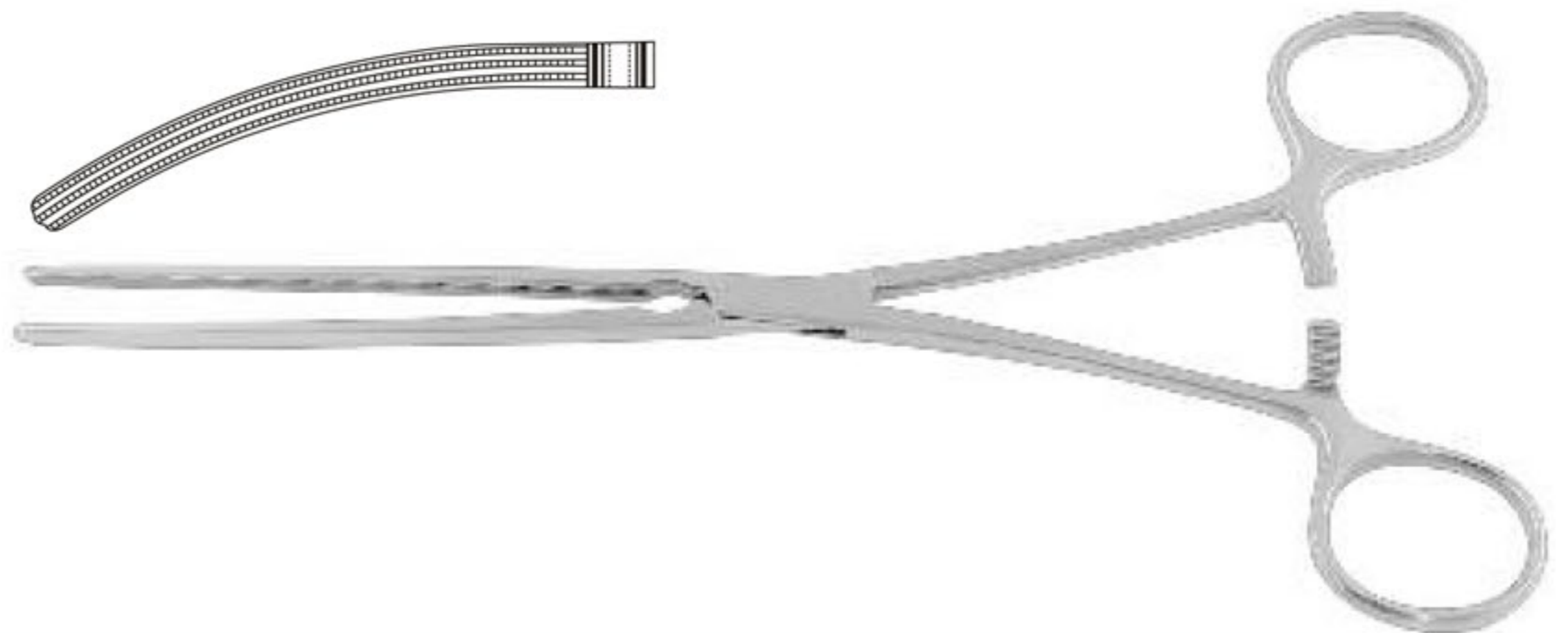

Catalog #	Size
MT-SI-14-176	13.5 cm (5 1/4")

Doyen Atrauma Intestinal Clamp

Straight

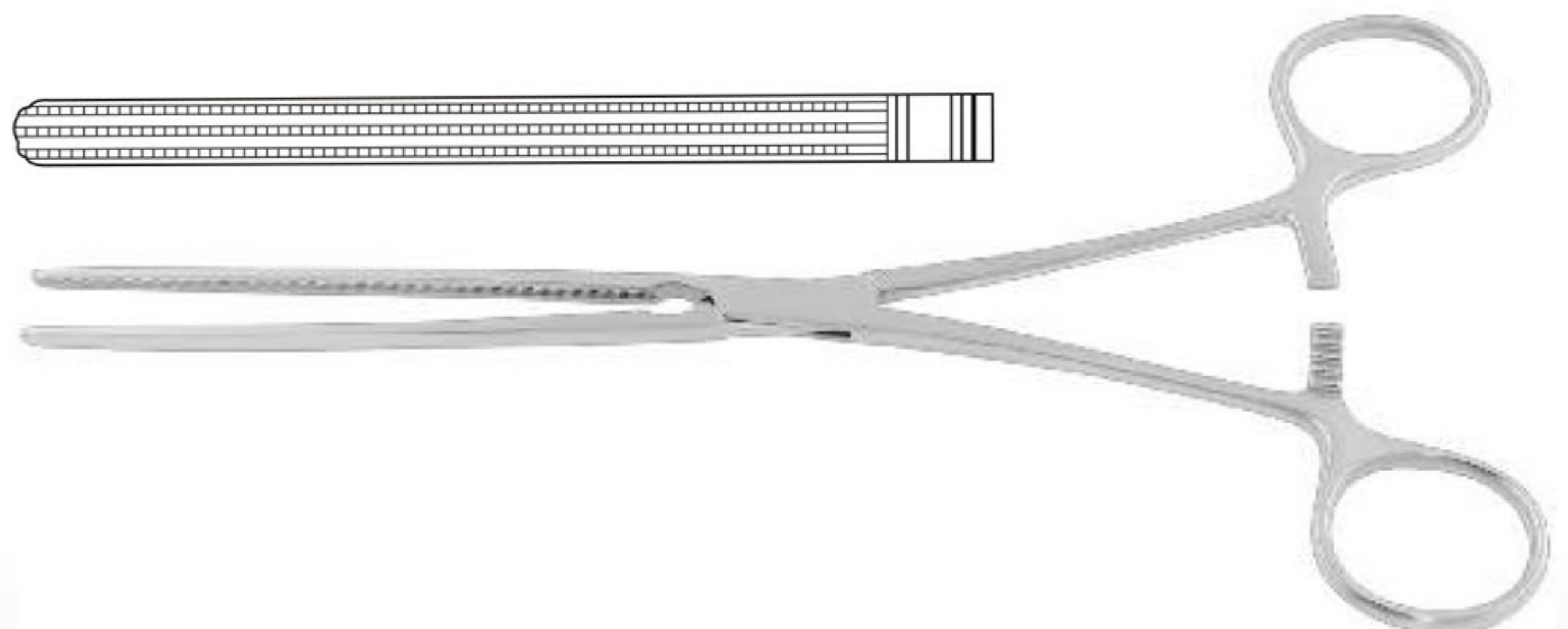
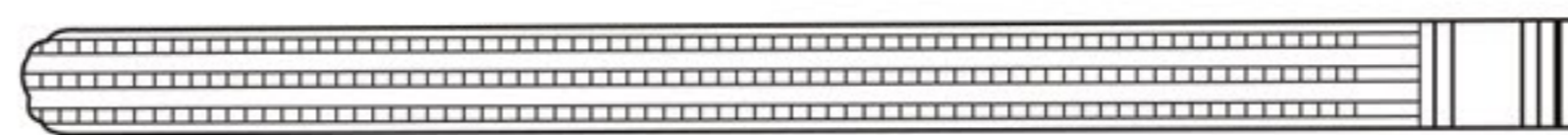

Catalog #	Size
MT-SI-14-177	17 cm (6 3/4")
MT-SI-14-178	18.5 cm (7 1/4")
MT-SI-14-179	21.5 cm (8 1/2")
MT-SI-14-180	23.5 cm (9 1/4")



STOMACH INSTRUMENTS RECTUM

Intestinal Clamps
Darmklemmen
Pinzas intestinales
Pinces intestinales
Pinze intestinali

Doyen Atrauma Intestinal Clamp

Curved

Catalog #	Size
MT-SI-14-181	17 cm (6 ¾")
MT-SI-14-182	18 cm (7")
MT-SI-14-183	21 cm (8 ¼")
MT-SI-14-184	23 cm (9")

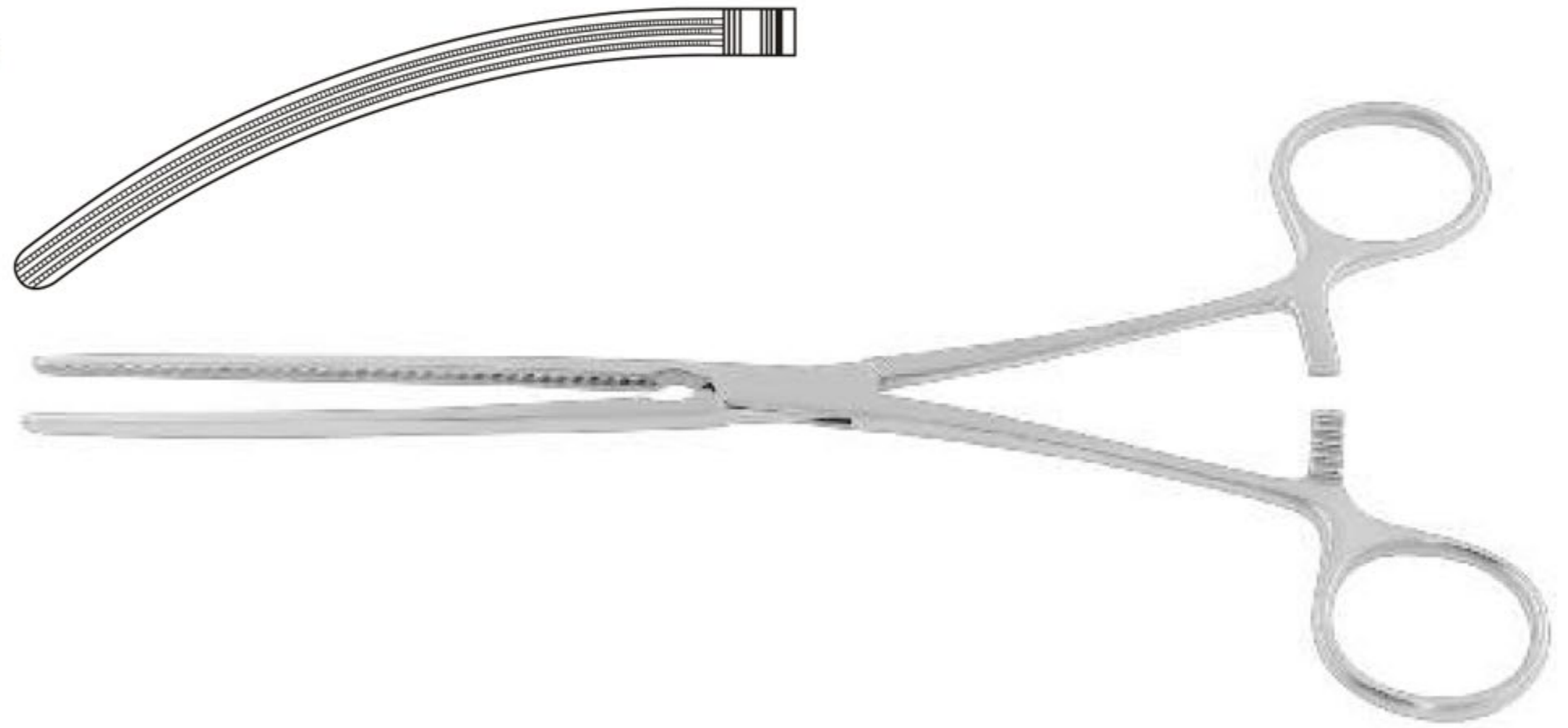

Mayo-Robson Atrauma Intestinal Clamp

Straight

Catalog #	Size
MT-SI-14-185	26 cm (10 ¼")



Mayo-Robson Atrauma Intestinal Clamp

Curved

Catalog #	Size
MT-SI-14-186	25 cm (9 ¾")

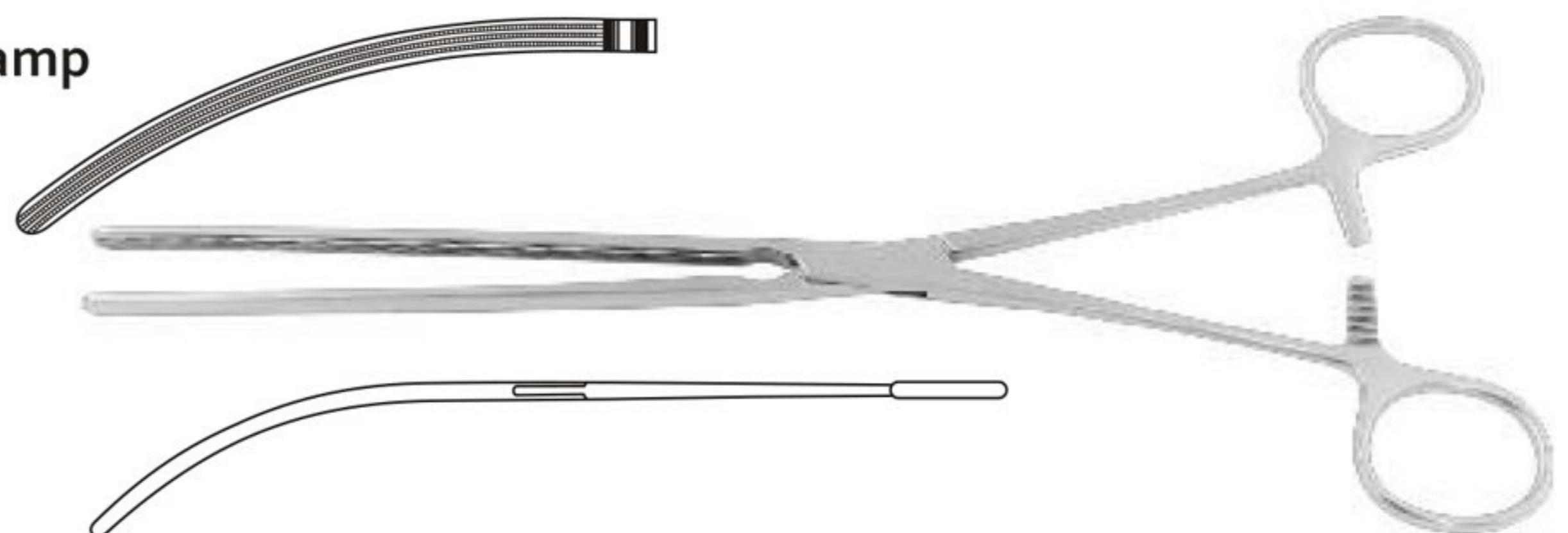

Kocher Atrauma Intestinal Clamp

Straight

Catalog #	Size
MT-SI-14-187	22.5 cm (8 ¾")
MT-SI-14-188	25.5 cm (10")
MT-SI-14-189	28 cm (11")

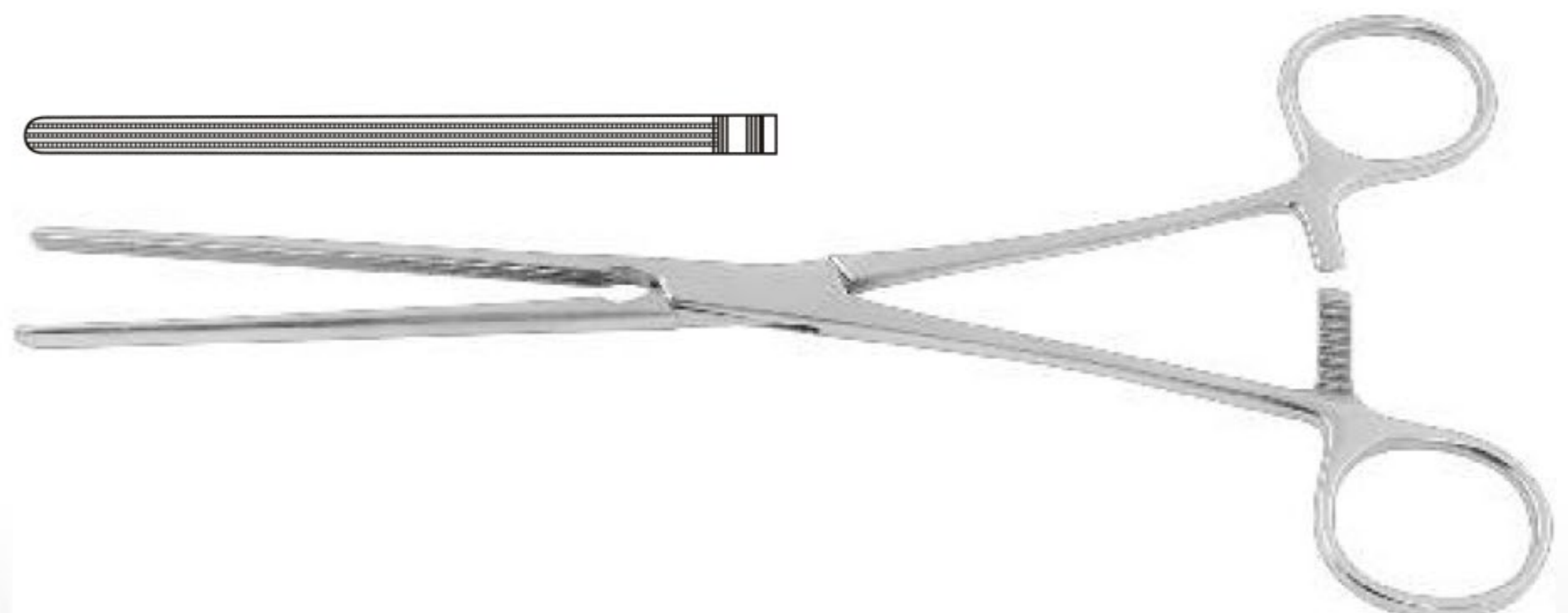



STOMACH INSTRUMENTS RECTUM

Intestinal Clamps
Darmklemmen
Pinzas intestinales
Pincas intestinales
Pinze intestinali

Kocher Atrauma Intestinal Clamp

Curved

Catalog #	Size
MT-SI-14-190	22 cm (8 3/4")
MT-SI-14-191	25 cm (9 3/4")
MT-SI-14-192	27.5 cm (10 3/4")

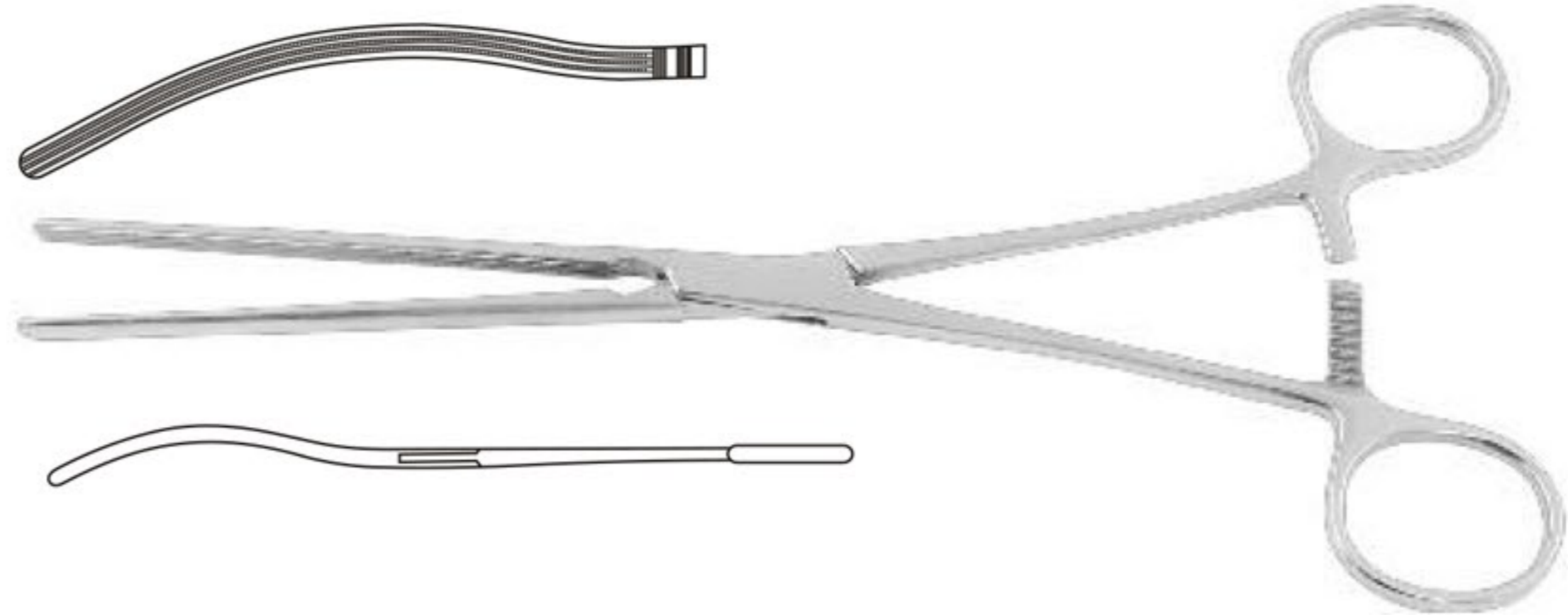

Scudder Atrauma Intestinal Clamp

Straight

Catalog #	Size
MT-SI-14-193	33.5 cm (13 1/4")



Scudder Atrauma Intestinal Clamp

Curved

Catalog #	Size
MT-SI-14-194	32.5 cm (12 3/4")

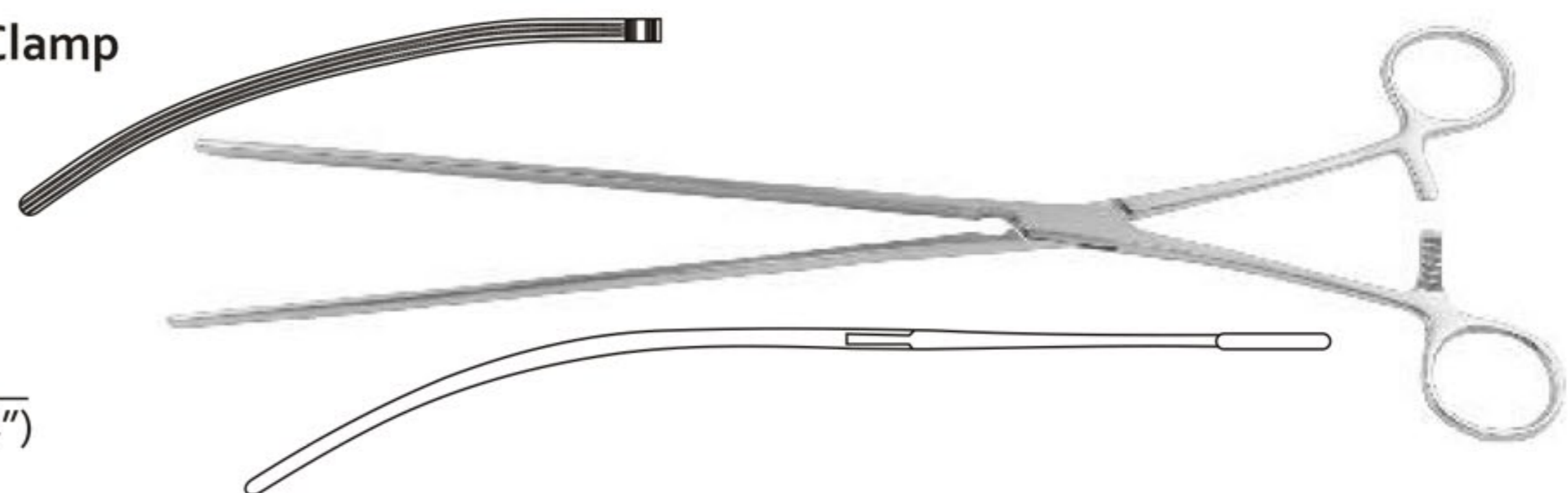

Brunner Atrauma Sigmoid Anastomosis Clamp

Catalog #	Size
MT-SI-14-195	27 cm (10 3/4")

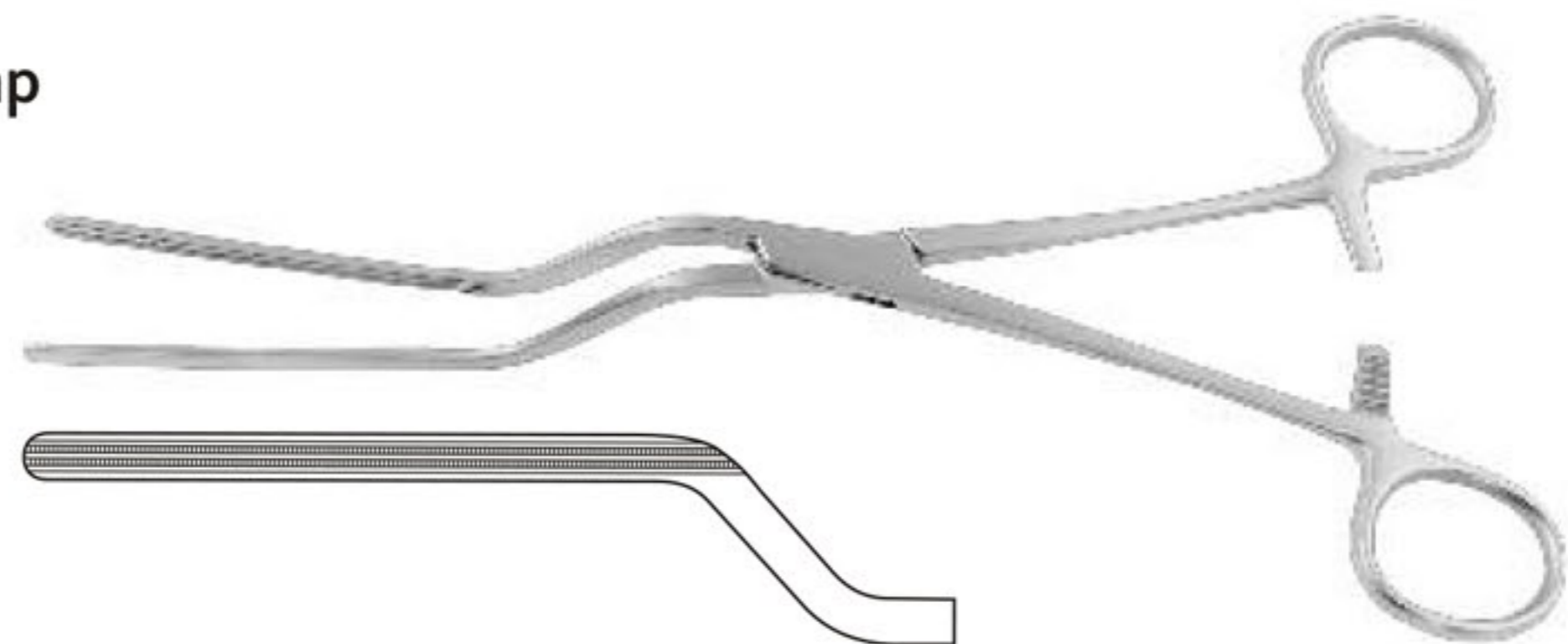

Hayes Atrauma Sigmoid Anastomosis Clamp

Catalog #	Size
MT-SI-14-196	27 cm (10 3/4")
MT-SI-14-197	28 cm (11")

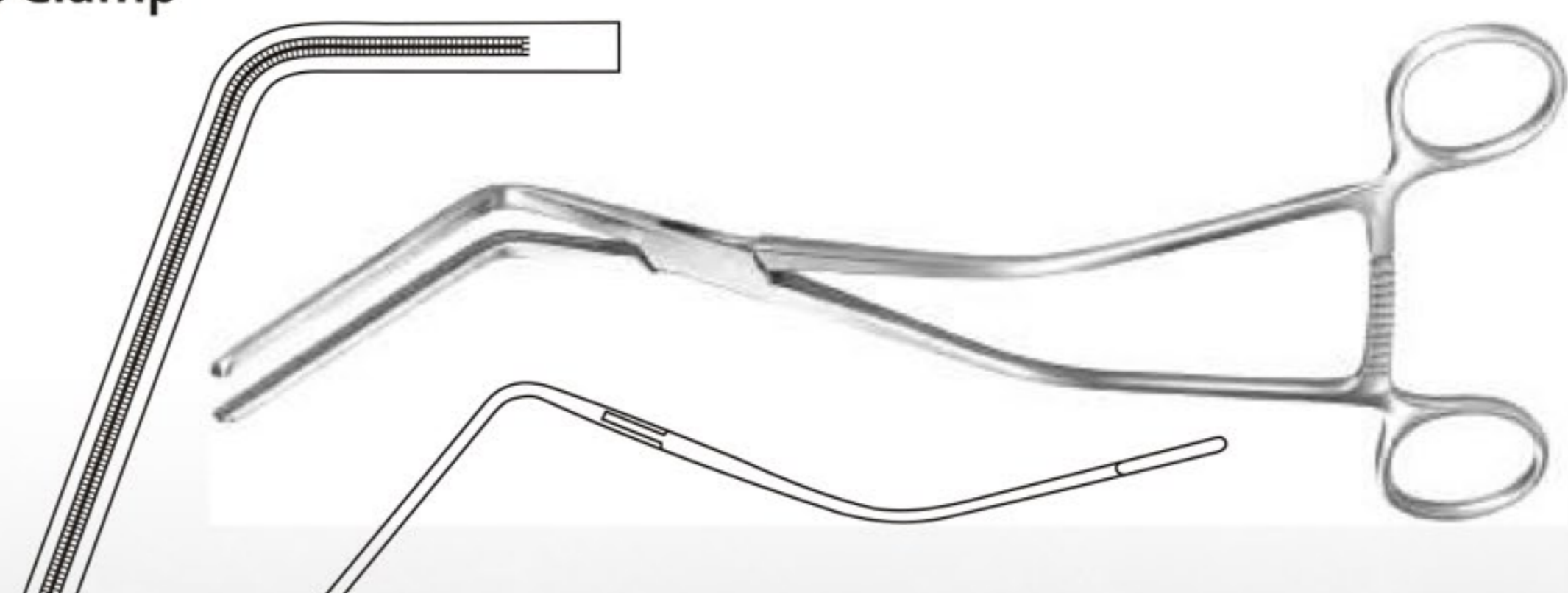



STOMAC INSTRUMENTS RECTUM

Intestinal Clamps, Rectal Specula
Darmklemmen, Mastdarmspekula
Pinzas intestinales, Espéculos rectales
Pincas intestinales, Spéculums rectaux
Pinze intestinali, Specoli rettali

Veidenheimer Atrauma Sigmoid Anastomosis Clamp

Catalog #	Size
MT-SI-14-198	25 cm (9 ¾")

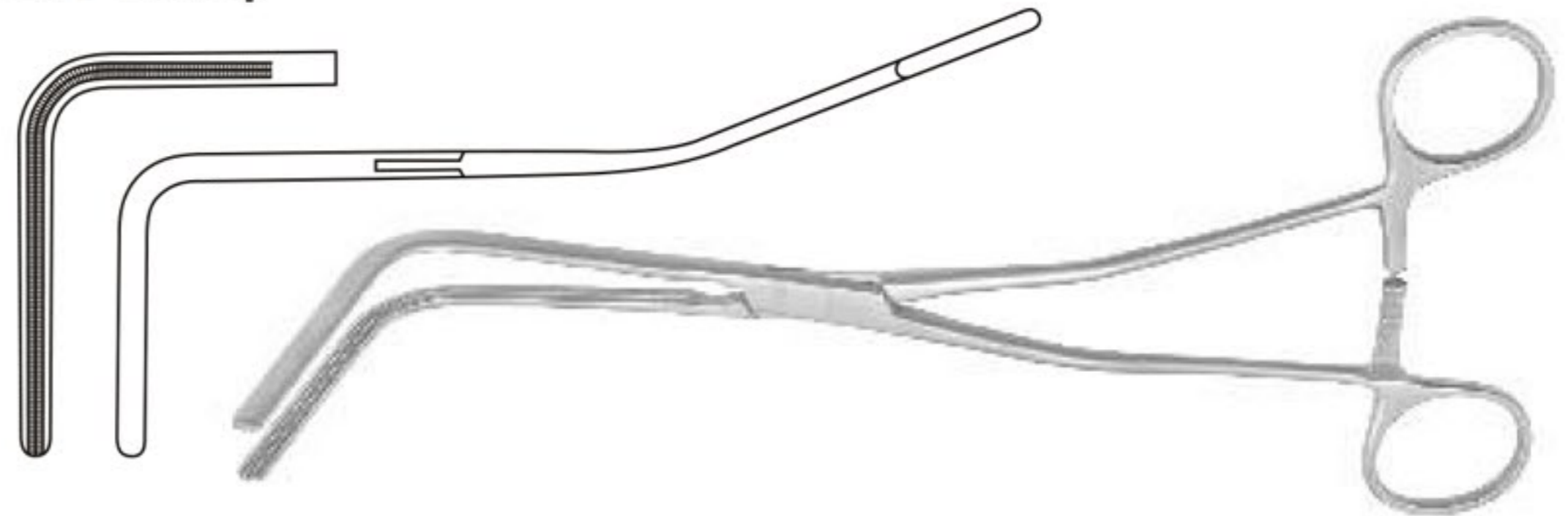

Fehland Atrauma Sigmoid Anastomosis Clamp

Catalog #	Size
MT-SI-14-199	24 cm (9 ½")

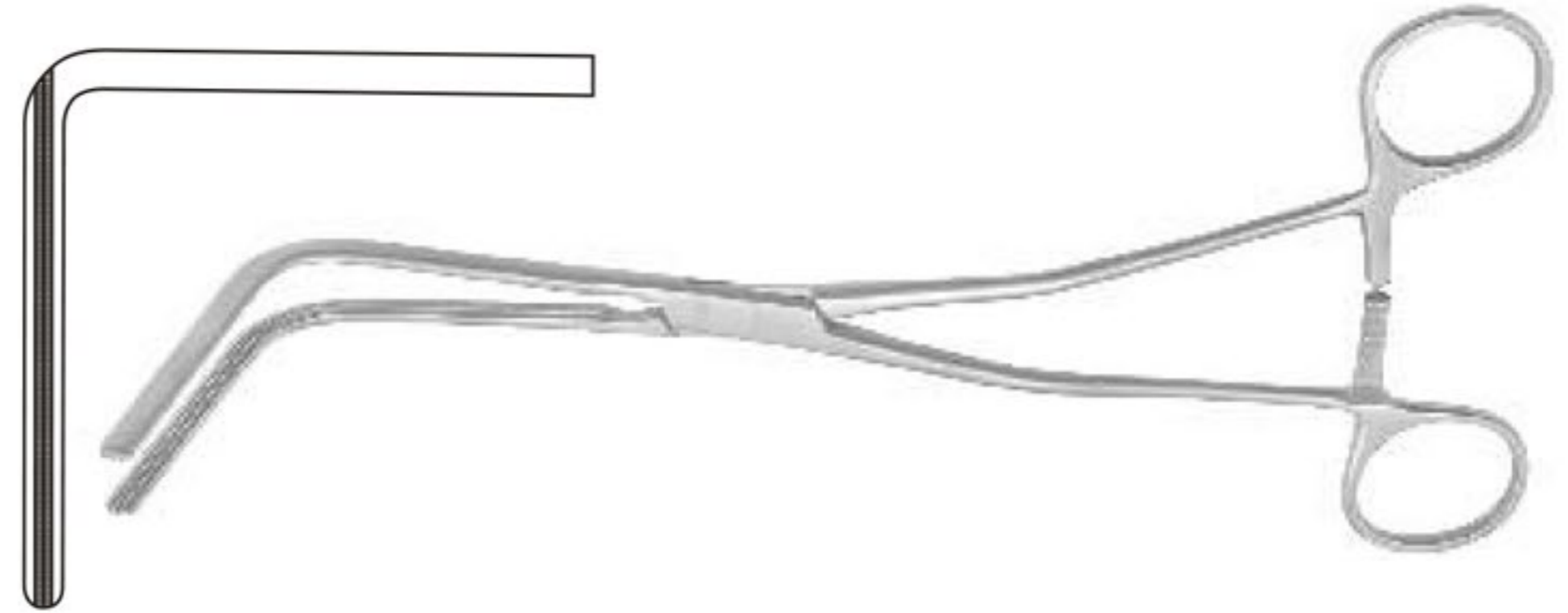

Resano Atrauma Sigmoid Anastomosis Clamp

Catalog #	Size
MT-SI-14-200	28 cm (11")

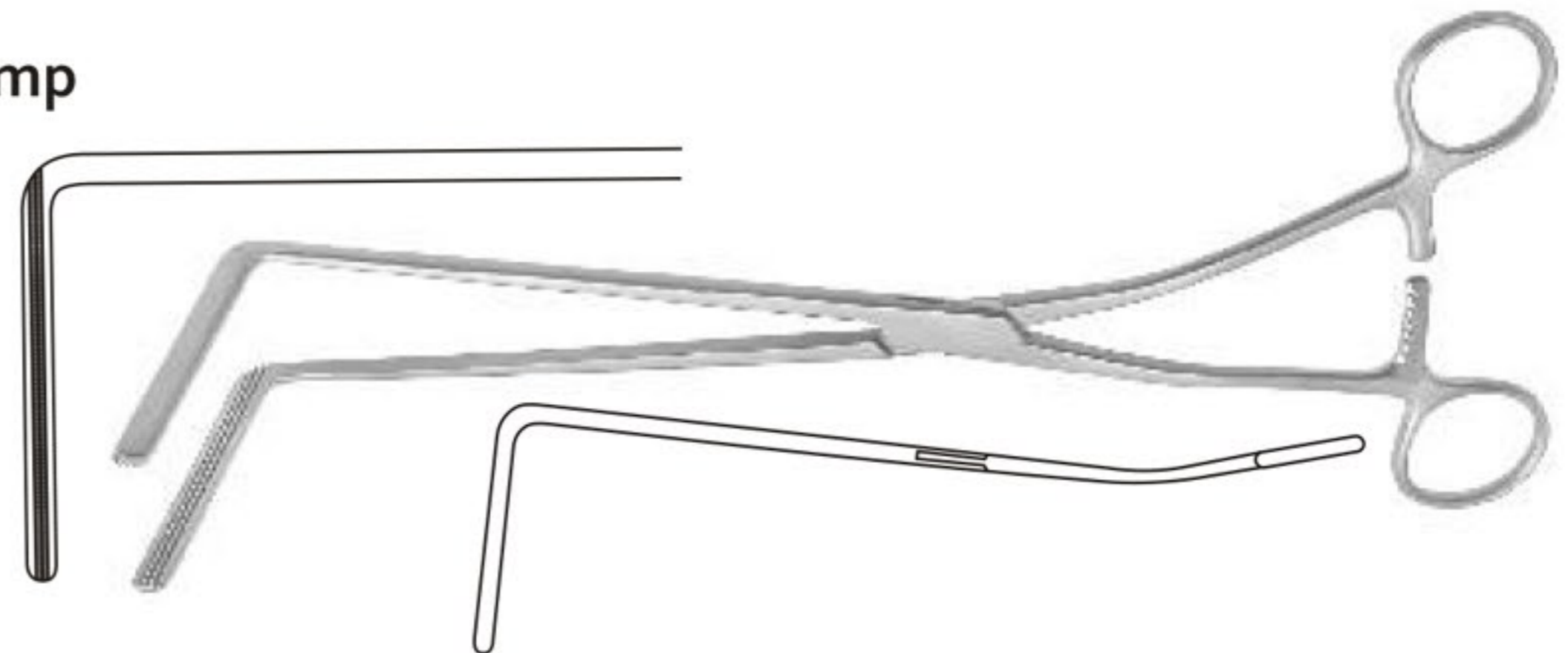

Czerny Rectal Speculum

Catalog #	Size
MT-SI-14-201	22 cm (8 ¾")



Pratt Rectal Speculum

Catalog #	Size, Blade Size
MT-SI-14-202	20.5 cm (8"), 80 x 25 mm





STOMACH INSTRUMENTS RECTUM

Rectal Specula
Mastdarmspekula
Espéculos rectales
Spéculums rectaux
Specoli rettali

Sims Rectal Speculum

Catalog #	Size, Blade Size
MT-SI-14-203	15.5 cm (6"), 70 x 15 mm



Sims Rectal Speculum With Fiber Optic Illumination

Catalog #	Size
MT-SI-14-204	15.5 cm (6")

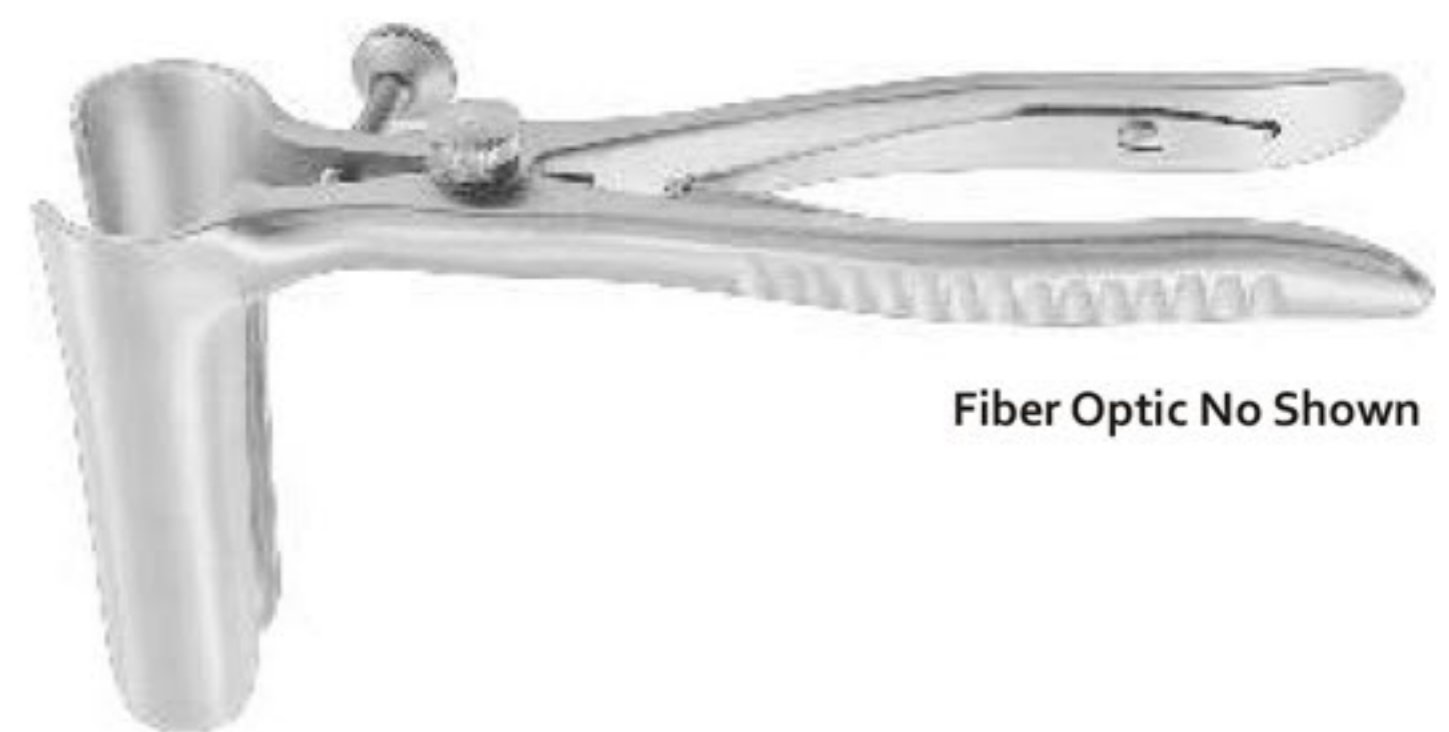

Fiber Optic No Shown

Sims Rectal Speculum Fenestrated Blades

Catalog #	Size, Blade Size
MT-SI-14-205	15.5 cm (6"), 70 x 15 mm



Sims (Schulze-Bergmann) Rectal Speculum

Catalog #	Size, Blade Size
MT-SI-14-206	22 cm (8 3/4"), 60 mm
MT-SI-14-207	22 cm (8 3/4"), 80 mm
MT-SI-14-208	22 cm (8 3/4"), 125 mm
MT-SI-14-209	22 cm (8 3/4"), 150 mm

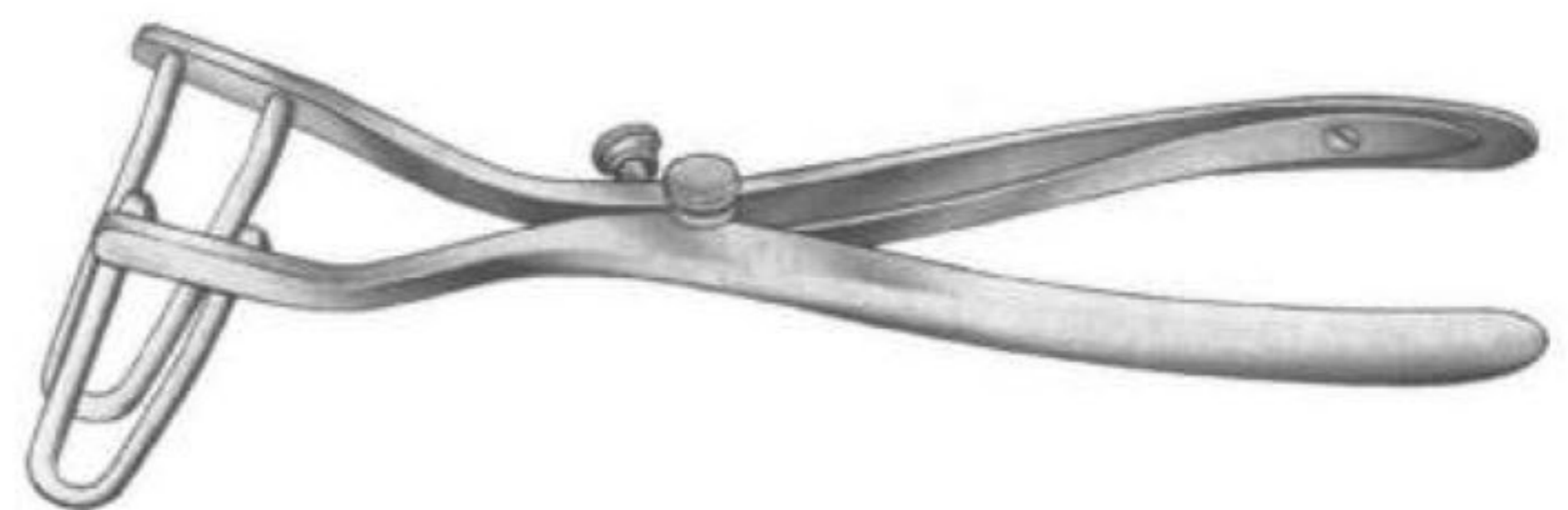

Sims (Schulze-Bergmann) Rectal Speculum With Fiber Optic Illumination

Catalog #	Size
MT-SI-14-210	22 cm (8 3/4")

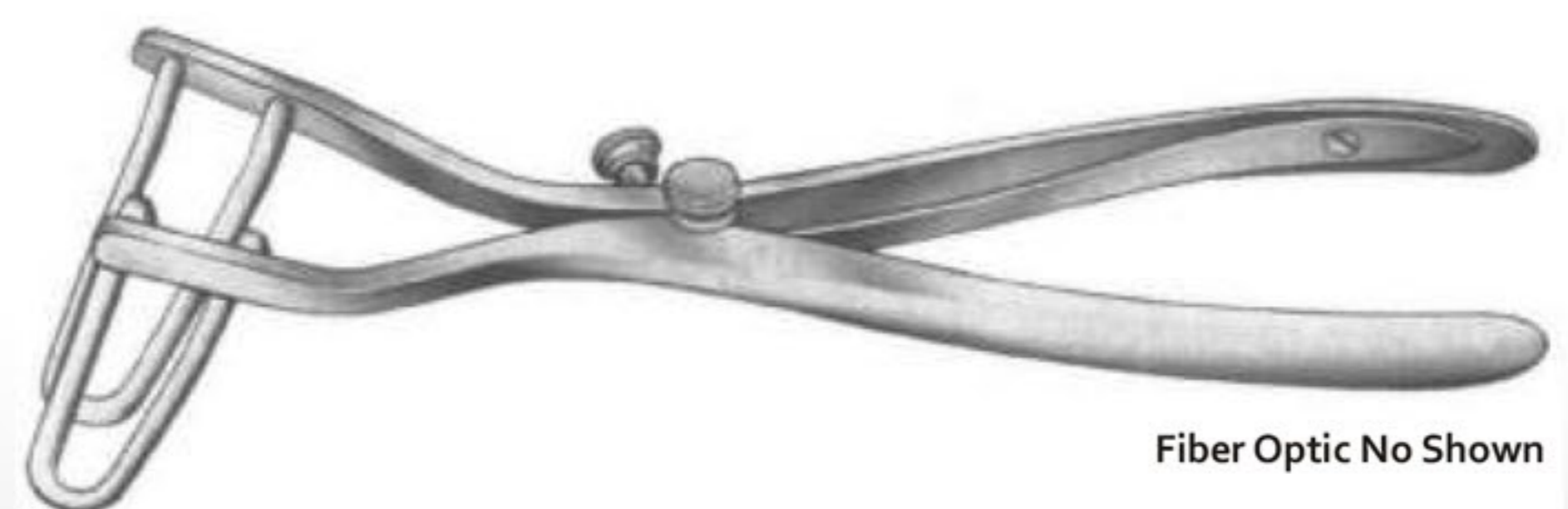

Fiber Optic No Shown



STOMAC INSTRUMENTS RECTUM

Rectal Specula
Mastdarmspekula
Espéculos rectales
Spéculums rectaux
Specoli rettali

Mathieu Rectal Speculum



Catalog #	Size, Blade Length
MT-SI-14-211	19.5 cm (7 3/4"), 90 mm

Barr Rectal Speculum



Catalog #	Size, Blade Size
MT-SI-14-212	17 cm (6 3/4"), 70 x 22 mm

Parks Rectal Speculum

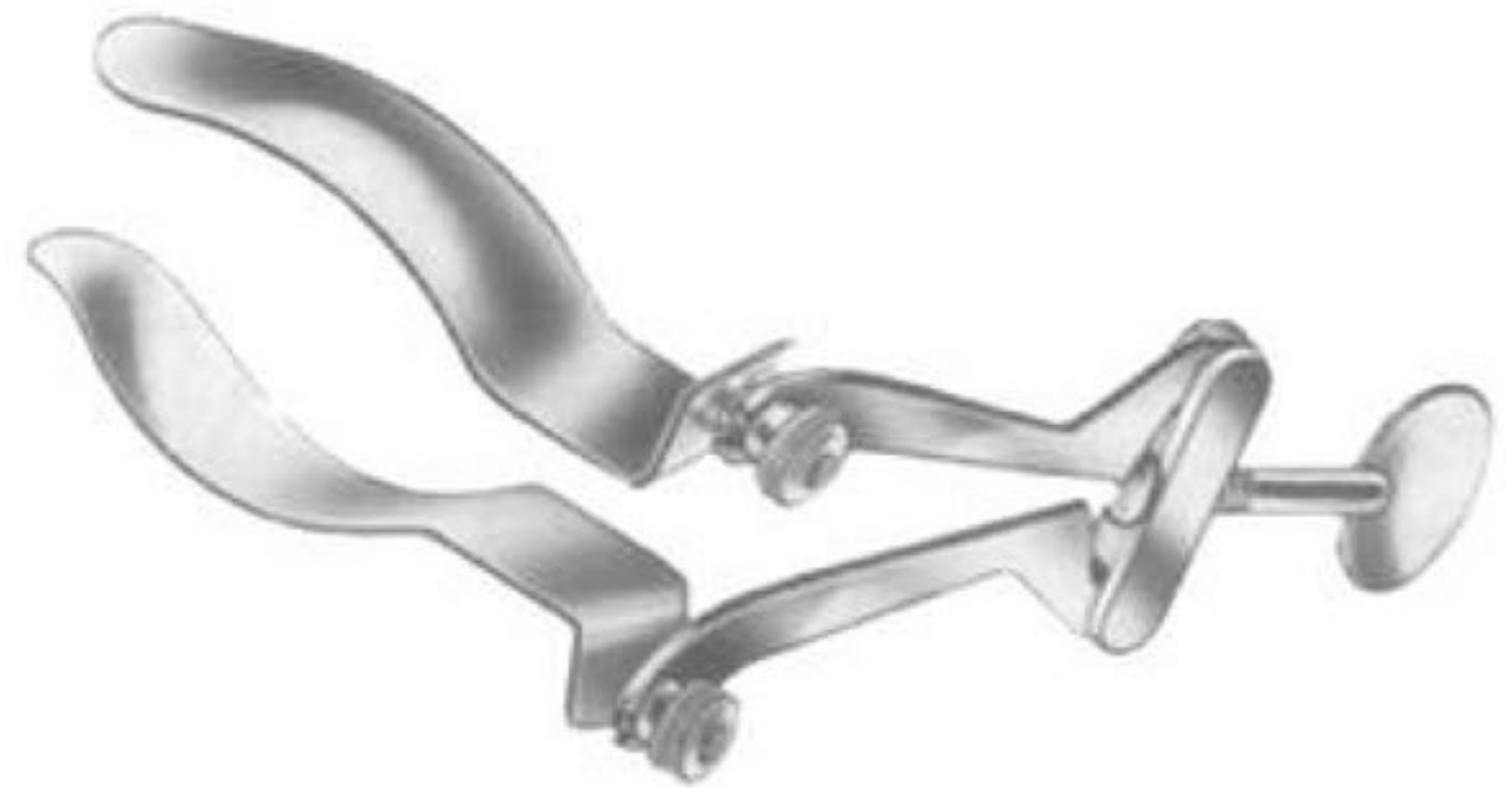

Catalog #	Size
MT-SI-14-213	N/A

Parks Rectal Speculum

With Fiber Optic Illumination

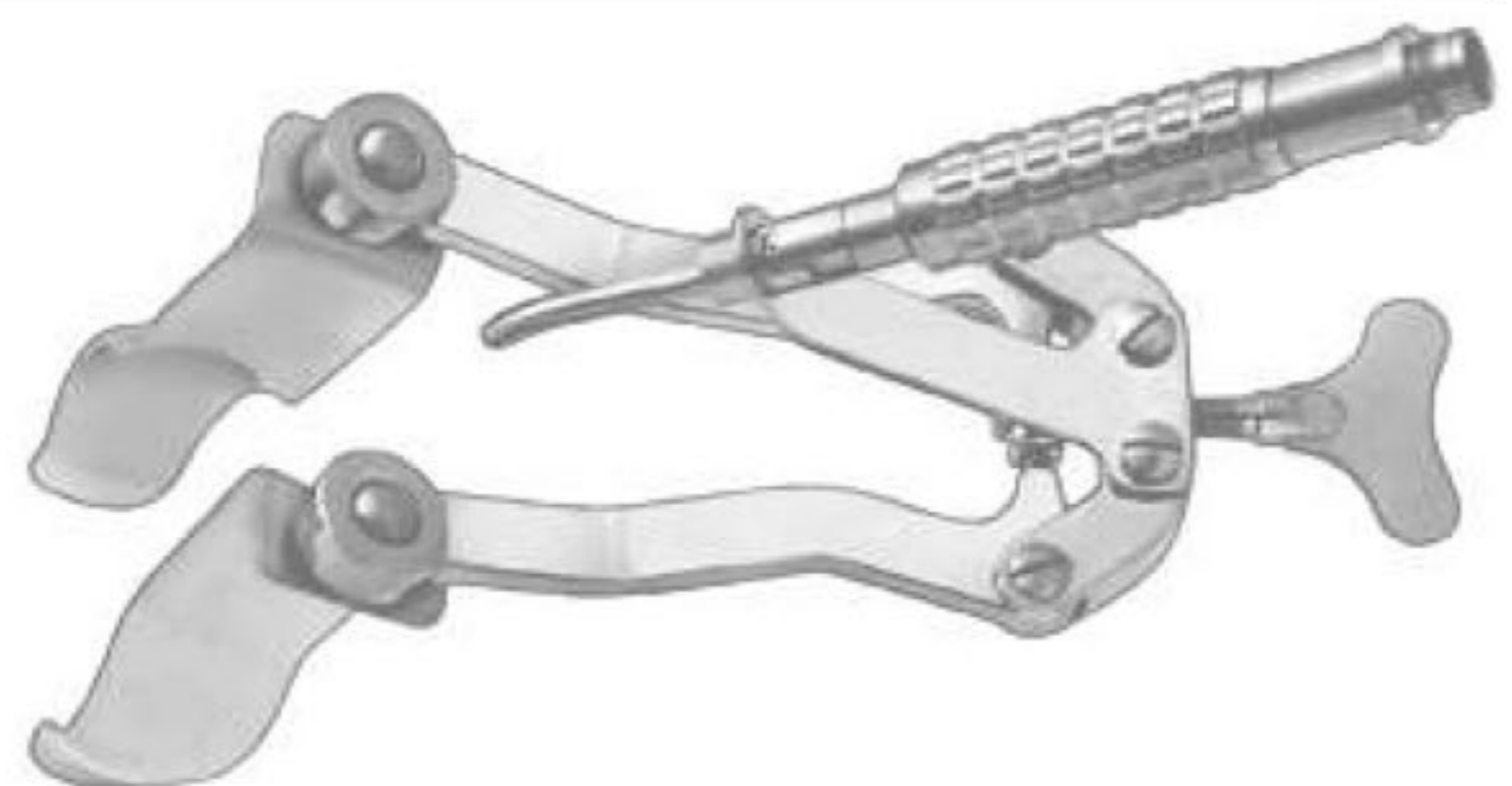

Catalog #	Size
MT-SI-14-214	N/A

Alan-Parks Rectal Speculum

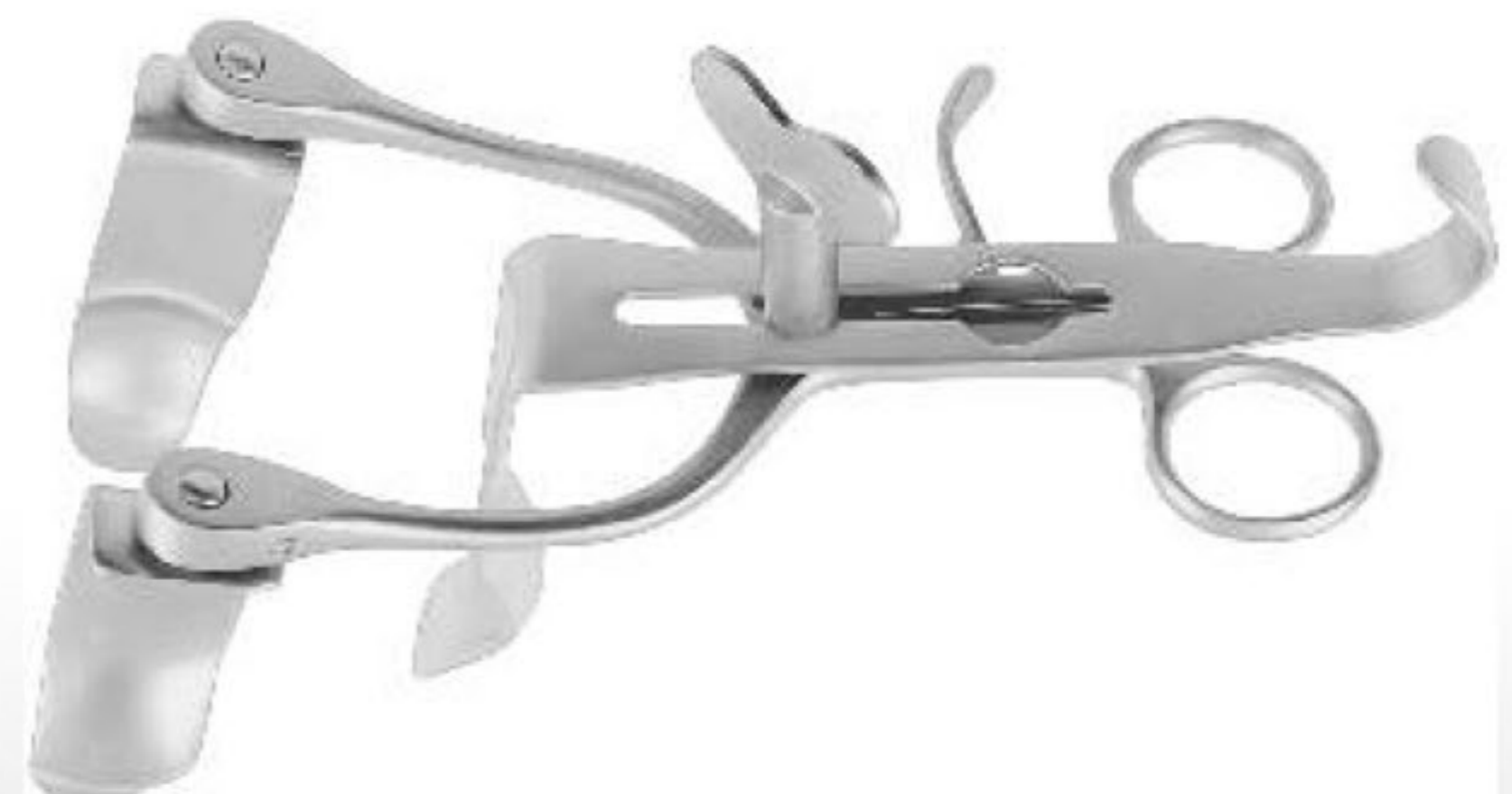

Catalog #	Size
MT-SI-14-215	N/A



Rectal Spreaders
Analspreizer
Separadores rectales
Ecarteurs rectaux
Divaricatori rettali

Alan-Parks Rectal Speculum

With Fiber Optic Illumination

Catalog #	Size
MT-SI-14-216	N/A



Roschke Anal Retractor

Catalog #	Blade Size
MT-SI-14-217	70 x 30 mm



Roschke Anal Retractor

With Fiber Optic Illumination

Catalog #	Blade Size
MT-SI-14-218	70 x 30 mm



Hirschmann Anusope

Catalog #	Diameter, Working Length, Profile
MT-SI-14-219	Ø 16 mm, 60 mm, Fig. 1
MT-SI-14-220	Ø 19 mm, 70 mm, Fig. 2
MT-SI-14-221	Ø 24 mm, 90 mm, Fig. 3
MT-SI-14-222	Ø 24 mm, 130 mm, Fig. 4





STOMAC INSTRUMENTS RECTUM

Anuscope
Anuskop
Anoscopio
Anuscope
Anoscopio

Hirschman Anusope

With Fiber Optic Illumination



Catalog #	Diameter, Working Length, Profile
MT-SI-14-223	Ø 16 mm, 60 mm, Fig. 1
MT-SI-14-224	Ø 19 mm, 70 mm, Fig. 2
MT-SI-14-225	Ø 24 mm, 90 mm, Fig. 3
MT-SI-14-226	Ø 24 mm, 130 mm, Fig. 4

Ives-Fansler Anusope



Catalog #	Diameter, Working Length
MT-SI-14-227	Ø 22 mm, 95 mm

Ives-Fansler Anusope

With Fiber Optic Illumination

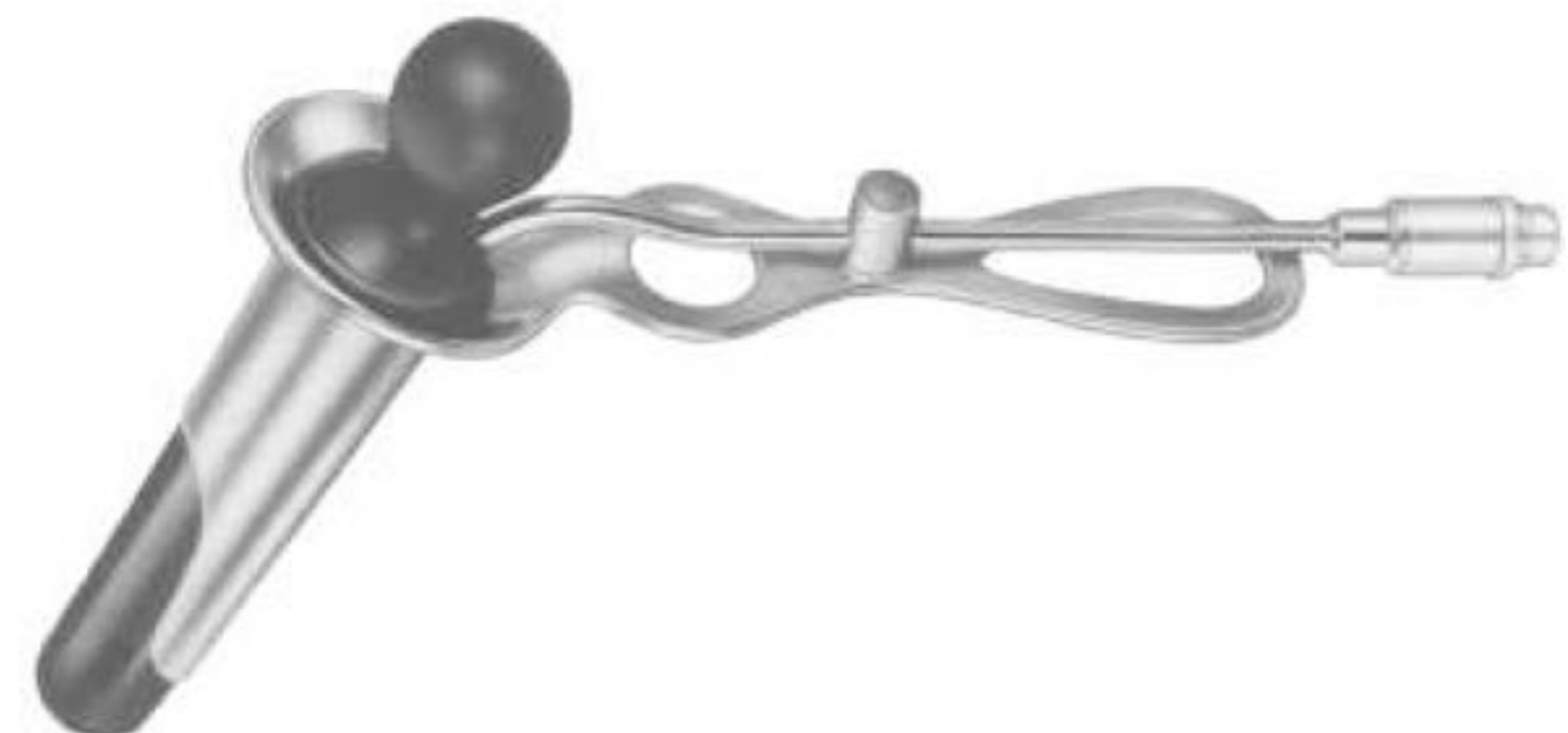

Catalog #	Diameter, Working Length
MT-SI-14-228	Ø 22 mm, 95 mm

Anusope

With Obturator



Catalog #	Diameter, Working Length
MT-SI-14-229	Ø 21 mm, 80 mm

Anusope

With Obturator



Catalog #	Diameter, Working Length
MT-SI-14-230	Ø 26 mm, 60 mm
MT-SI-14-231	Ø 24 mm, 80 mm



STOMAC INSTRUMENTS RECTUM

Proctoscopes
Proktoskope
Proctoscopios
Proctoscopes
Protoscopi

Kelly Proctoscope



Catalog #	Diameter, Working Length, Profile
MT-SI-14-232	Ø 22 mm, 50 mm, Fig. 1
MT-SI-14-233	Ø 22 mm, 100 mm, Fig. 2
MT-SI-14-234	Ø 22 mm, 140 mm, Fig. 3
MT-SI-14-235	Ø 22 mm, 200 mm, Fig. 4

Proctoscope

With Obturator

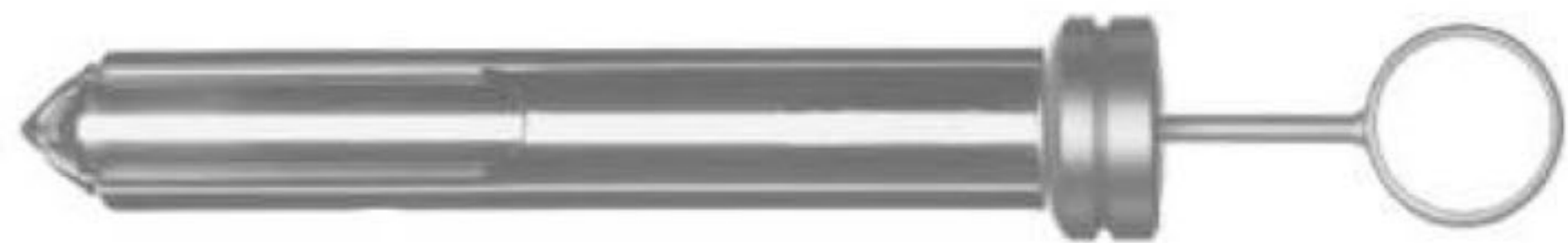

Catalog #	Diameter, Working Length
MT-SI-14-236	Ø 22 mm, 120 mm

Blond Proctoscope Complete

With Conventional Illumination and Tube Ref: SI-440-01



Catalog #	Size
MT-SI-14-237	N/A

Battery Handle Only

For 2 x "C" Type Batteries

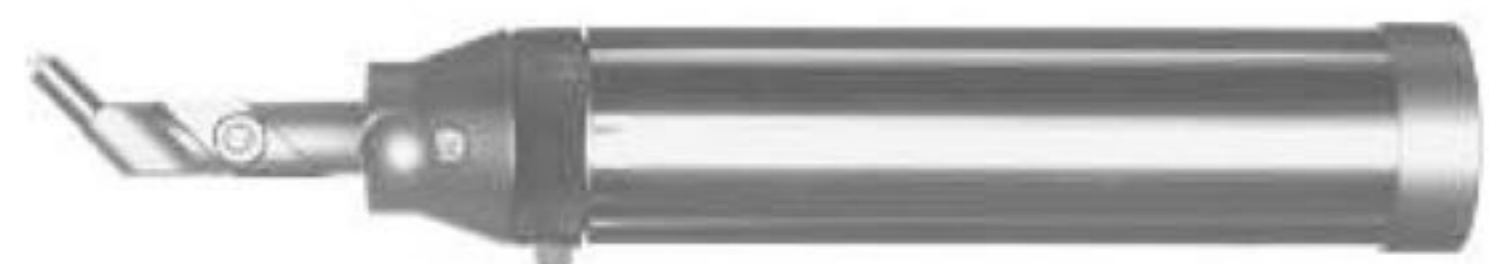

Catalog #	Size
MT-SI-14-238	N/A

Head End Only



Catalog #	Size
MT-SI-14-239	N/A



STOMAC INSTRUMENTS RECTUM

Proctoscopes
Proktoskope
Proctoscopios
Proctoscopes
Protoscopi

Bulb

Head End Only



<u>Catalog #</u>	<u>Power Rating</u>
MT-SI-14-240	2.5

Bulb

Short for Head End Only



<u>Catalog #</u>	<u>Power Rating</u>
MT-SI-14-241	2.5

Blond Proctoscope Complete

With Fiber Optic Illumination and Tube Ref: SI-440-01

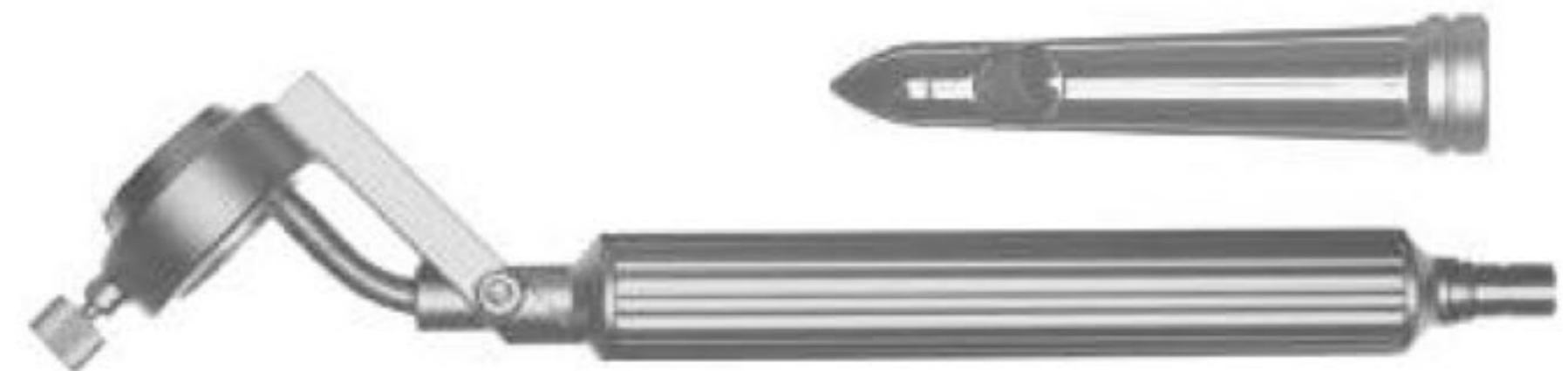

<u>Catalog #</u>	<u>Size</u>
MT-SI-14-242	N/A

Illumination Handle only

With Head End



<u>Catalog #</u>	<u>Size</u>
MT-SI-14-243	N/A

Adaptor

Storz Type



<u>Catalog #</u>	<u>Size</u>
MT-SI-14-244	N/A



STOMAC INSTRUMENTS RECTUM

Proctoscopes
Proktoskope
Proctoscopios
Proctoscopes
Protoscopi

Blond Proctoscope Tube

Catalog #	Diameter, Working Length
MT-SI-14-245	Ø 18:24 mm, 75 mm
MT-SI-14-246	Ø 15:23 mm, 75 mm
MT-SI-14-247	Ø 18:25 mm, 105 mm

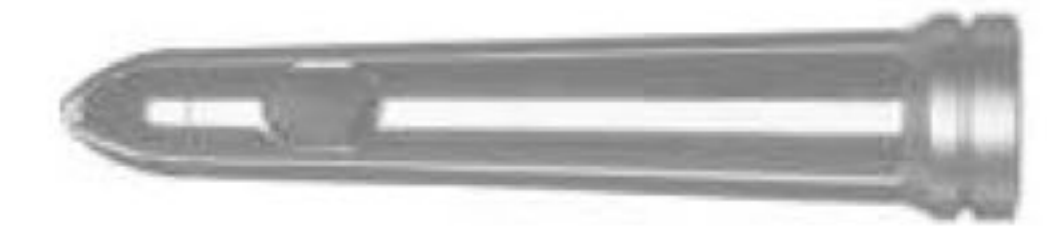

SI-14-245



SI-14-246



SI-14-247

Blond Proctoscope Tube

Circular Fenestration

Catalog #	Diameter, Working Length
MT-SI-14-248	Ø 18:24 mm, 75 mm



Morgan Proctoscope

With Fiber Optic Illumination

Catalog #	Diameter, Working Length
MT-SI-14-249	Ø 17 mm, 65 mm
MT-SI-14-250	Ø 17 mm, 80 mm
MT-SI-14-251	Ø 20 mm, 65 mm
MT-SI-14-252	Ø 20 mm, 80 mm
MT-SI-14-253	Ø 24 mm, 65 mm
MT-SI-14-254	Ø 24 mm, 80 mm



Morgan Fibre Optic Illuminator

Connectors Type Storz, Wolf, ACM

Catalog #	Size
MT-SI-14-255	N/A





STOMAC INSTRUMENTS RECTUM

Sphincteroscopes, Rectoscopes
Sphinkteroskope, Rektoskope
Esfincteroscopios, Rectoscopios
Sphinctérosopes, Rectoscopes
Sfincteroscopi, Rectotoscopi

Kelly Sphincteroscope



Catalog #	Diameter, Diameter, Profile
MT-SI-14-256	Ø 21 mm, 50 mm, Fig. 1
MT-SI-14-257	Ø 27 mm, 50 mm, Fig. 2

Rectoscope Complete

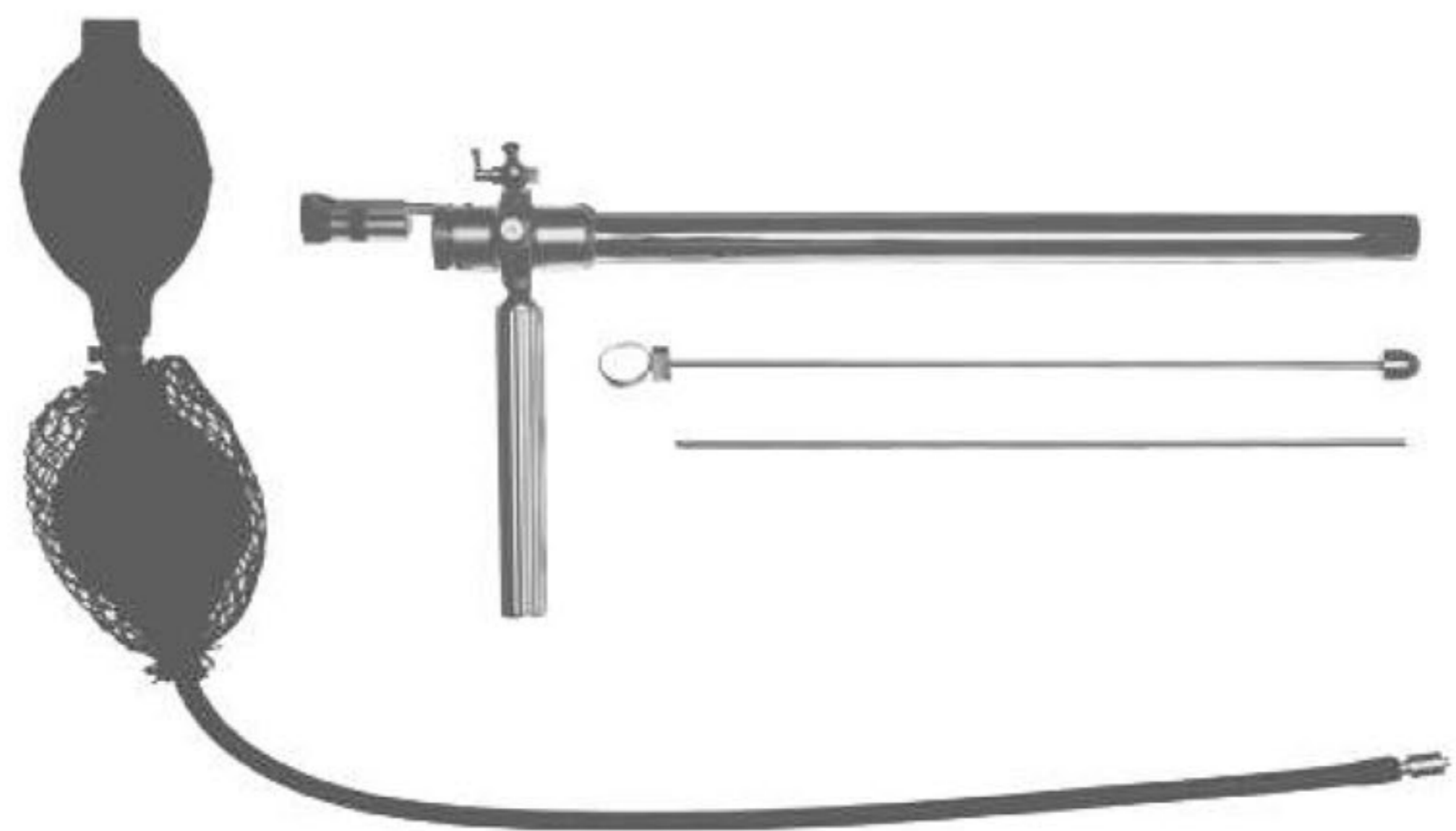

Catalog #	Size
MT-SI-14-258	N/A

Strauss Rectoscope Complete

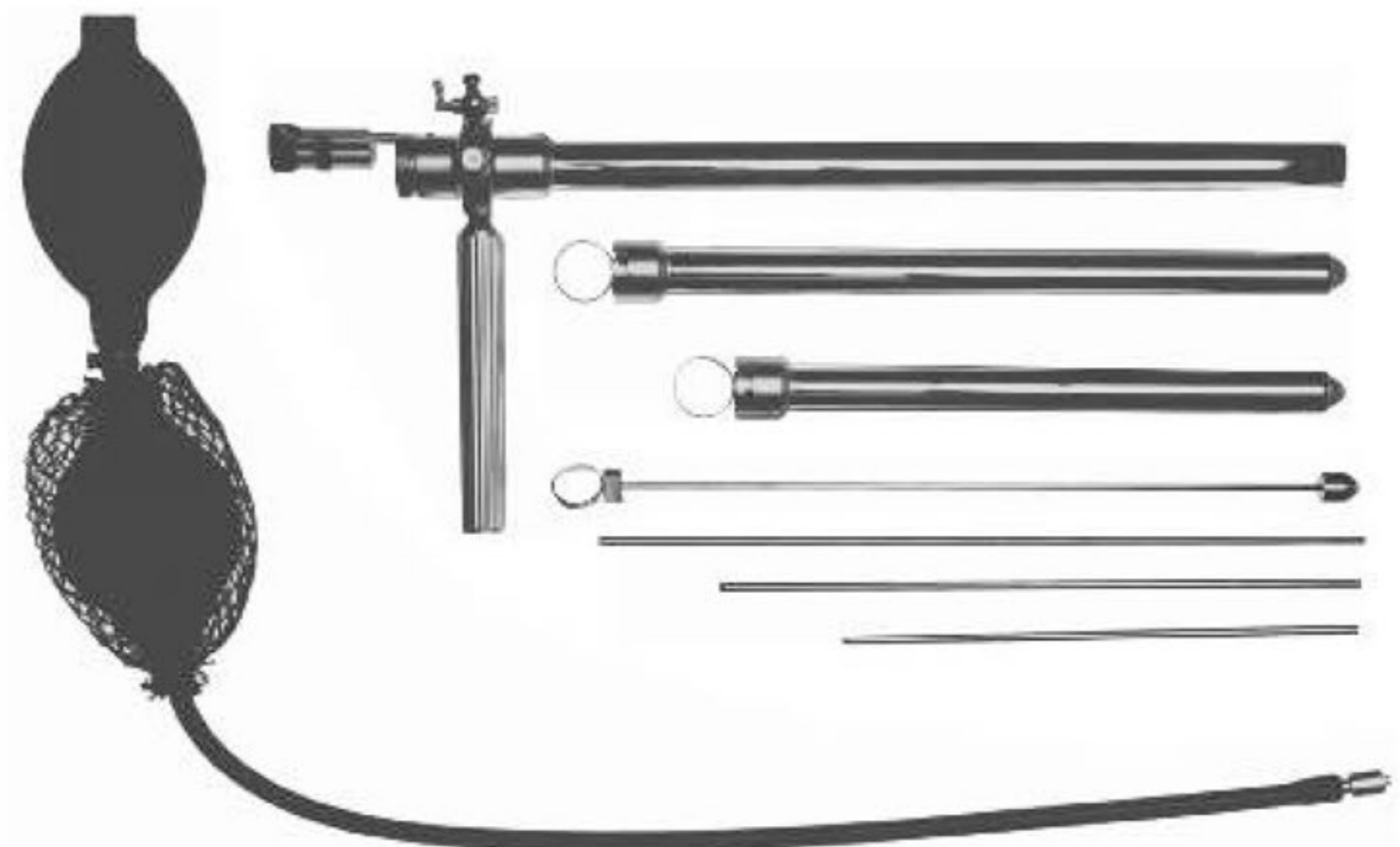

Catalog #	Size
MT-SI-14-259	N/A

Recto-Rectoscope Complete

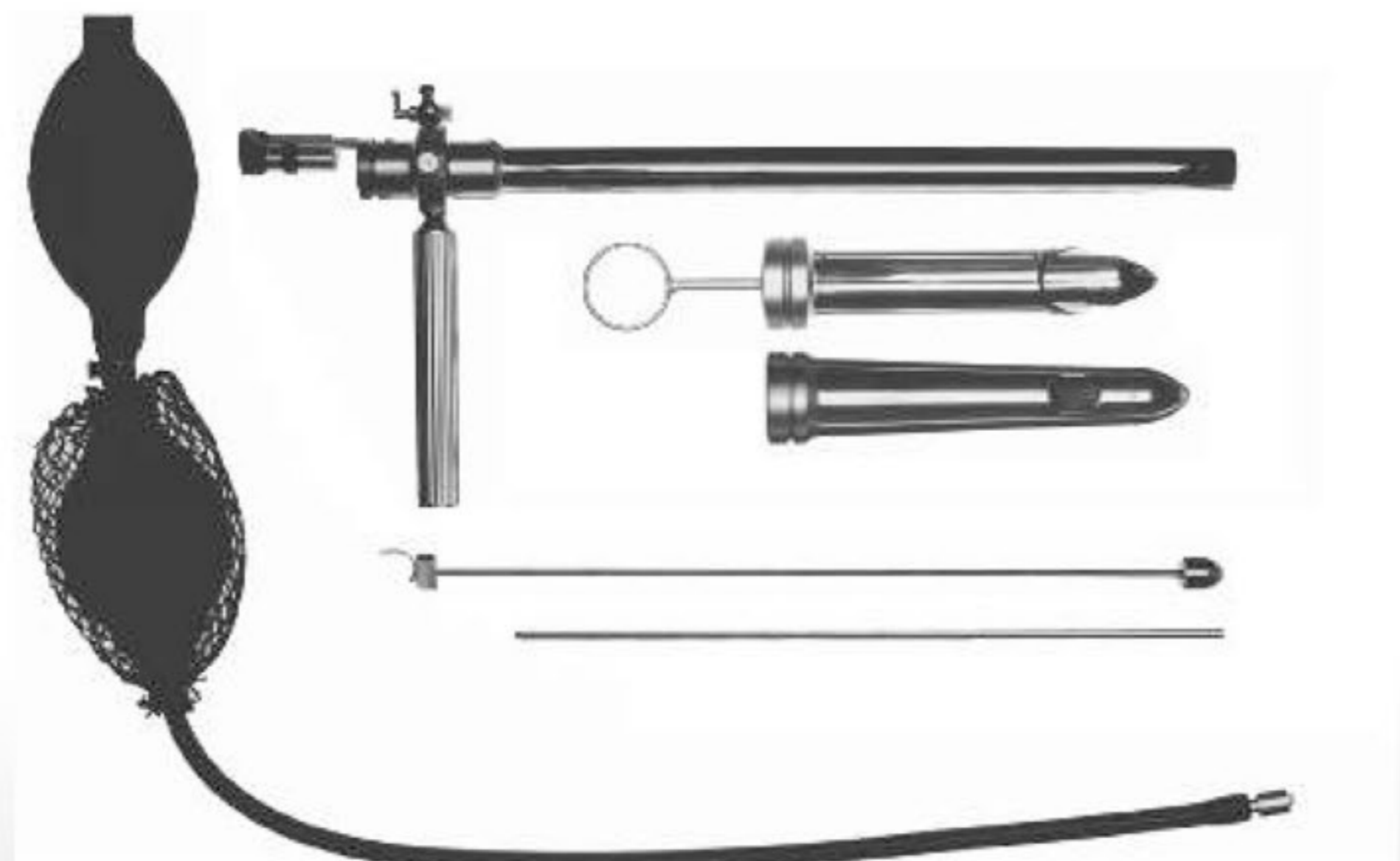

Catalog #	Size
MT-SI-14-260	N/A



STOMAC INSTRUMENTS RECTUM

Sphincteroscopes, Rectoscopes
Sphinkteroskope, Rektoskope
Esfincteroscopios, Rectoscopios
Sphinctérosopes, Rectoscopes
Sfincteroscopi, Rectotoscopi

Battery Handle Only

For 2 x "AAA" Type Batteries



Catalog #	Size
MT-SI-14-261	N/A

Spare Bulb

Xenon



Catalog #	Power Rating
MT-SI-14-262	2.5 V

Adapter

Wolf Type



Catalog #	Size
MT-SI-14-263	N/A

Adapter

Storz / Olympus Type



Catalog #	Size
MT-SI-14-264	N/A

Adapter

Storz / Olympus Type / Aesculap Type



Catalog #	Size
MT-SI-14-265	N/A



STOMAC INSTRUMENTS RECTUM

Sphincteroscopes, Rectoscopes
Sphinkteroskope, Rektoskope
Esfincteroscopios, Rectoscopios
Sphinctérosopes, Rectoscopes
Sfincteroscopi, Rectotoscopi

Rectoscope Head

With 2 Way Stopcock, Connector Type Wolf



Catalog #	Size
MT-SI-14-266	N/A

Handle for Rectoscope Head



Catalog #	Size
MT-SI-14-267	N/A

Rectoscope Obturator



Catalog #	Size
MT-SI-14-268	N/A
MT-SI-14-269	N/A
MT-SI-14-270	N/A

Rectoscope Tube



Catalog #	Size
MT-SI-14-271	N/A
MT-SI-14-272	N/A
MT-SI-14-273	N/A

Fiber Optic Light Guide



Catalog #	Size
MT-SI-14-274	N/A
MT-SI-14-275	N/A
MT-SI-14-276	N/A



STOMAC INSTRUMENTS RECTUM

Sphincteroscopes, Rectoscopes
Spinkteroskope, Rektoskope
Esfincteroscopios, Rectoscopios
Sphinctérosopes, Rectoscopes
Sfincteroscopi, Rectotoscopi

Conical Tube

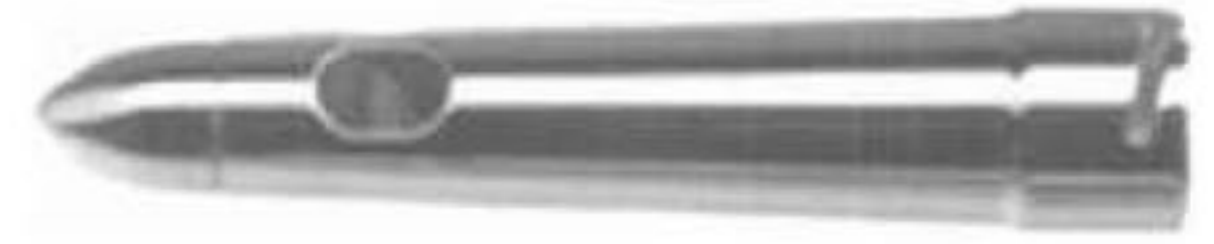

Catalog #	Size
MT-SI-14-177	N/A

Anuscope

With Obturator

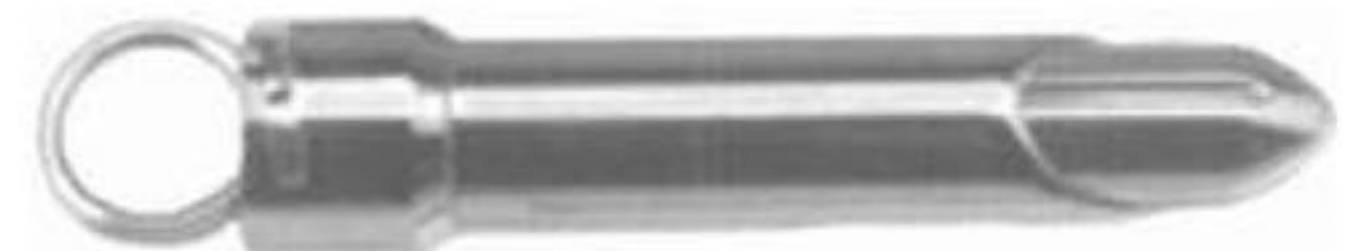

Catalog #	Size
MT-SI-14-278	N/A

Telescope



Catalog #	Size
MT-SI-14-279	N/A

Swivel Lens



Catalog #	Size
MT-SI-14-280	N/A

Cover



Catalog #	Size
MT-SI-14-281	N/A



STOMAC INSTRUMENTS RECTUM

Hemorrhoidal Ligator
Hämorrhoidal-Faßzange
Ligador para hemorroides
Ligateur pour hémorroïdes
Legatore emorroidale

Double-Blower

With Luer Lock

Catalog #	Size
MT-SI-14-282	N/A



Norwood Rectal Snare

Catalog #	Size
MT-SI-14-283	30 cm (11 3/4")



Blue Rectal Aspiration Cannula

10 Charr.

Catalog #	Size, Diameter
MT-SI-14-284	40 cm (15 3/4"), Ø 3.3 mm

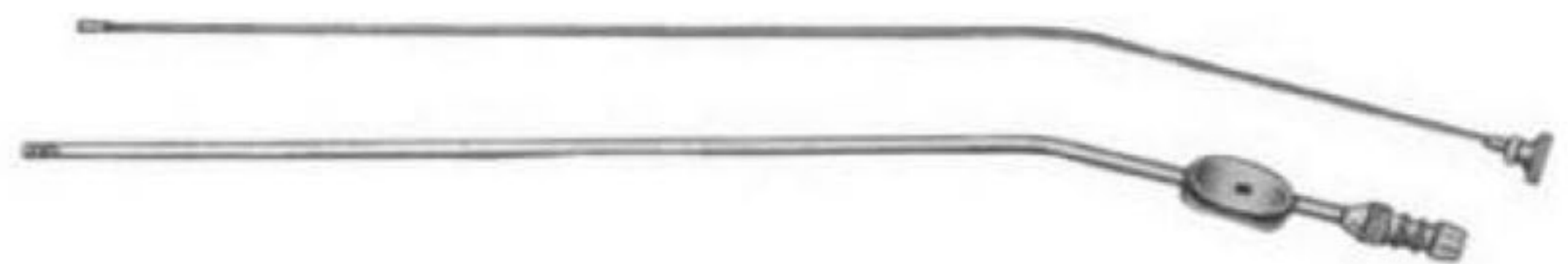

McGivney Suction Hemorrhoidal Ligator Complete

With 10 mm Suction Head and Charging Cone

Catalog #	Size
MT-SI-14-285	N/A



Suction Hemorrhoidal Ligator Complete

Angled 30° Up, With 10 mm Suction Head and Charging Cone

Catalog #	Size
MT-SI-14-286	N/A





STOMAC INSTRUMENTS RECTUM

Hemorrhoidal Ligator
Hämorrhoidal-Faßzange
Ligador para hemorroides
Ligateur pour hémorroïdes
Legatore emorroidale

Suction Hemorrhoidal Ligator Complete

Angled 30° Down, With 10 mm Suction Head and Charging Cone



Catalog #	Size
MT-SI-14-287	N/A

Rudd Hemorrhoidal Ligator Complete

With 12 mm Charging Cone



Catalog #	Size
MT-SI-14-288	31.5 cm (12 1/2")

McGiveny Hemorrhoidal Ligator Complete

With 12 mm Charging Cone



Catalog #	Size
MT-SI-14-289	N/A

Ford Dixon Hemorrhoidal Ligator Complete

With 12 mm Charging Cone



Catalog #	Size
MT-SI-14-290	N/A

Rubber Ligator Rings

Pack of 100



Catalog #	Size
MT-SI-14-291	N/A



STOMAC INSTRUMENTS RECTUM

Rectal Biopsy Forceps
Rektum-Biopsiefasszangen
Pinzas para biopsia rectal
Pincas pour biopsie rectale
Pinze per biopsia rettale

McGiveny Hemorrhoidal Grasping Forcep

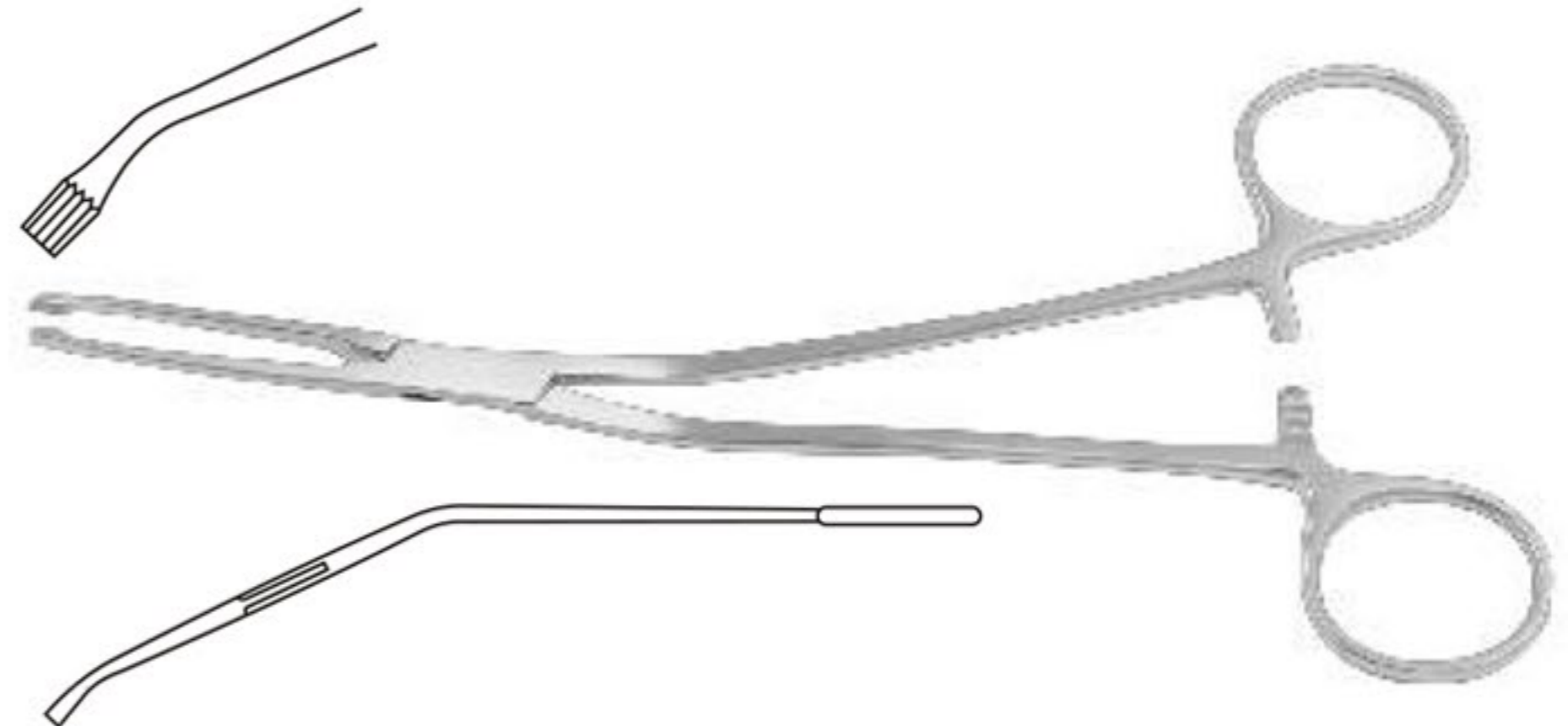

Catalog #	Size
MT-SI-14-292	19 cm (7 1/2")

Yeoman (Turrell) Rectal Biopsy Forcep Without Handle

Rotatable

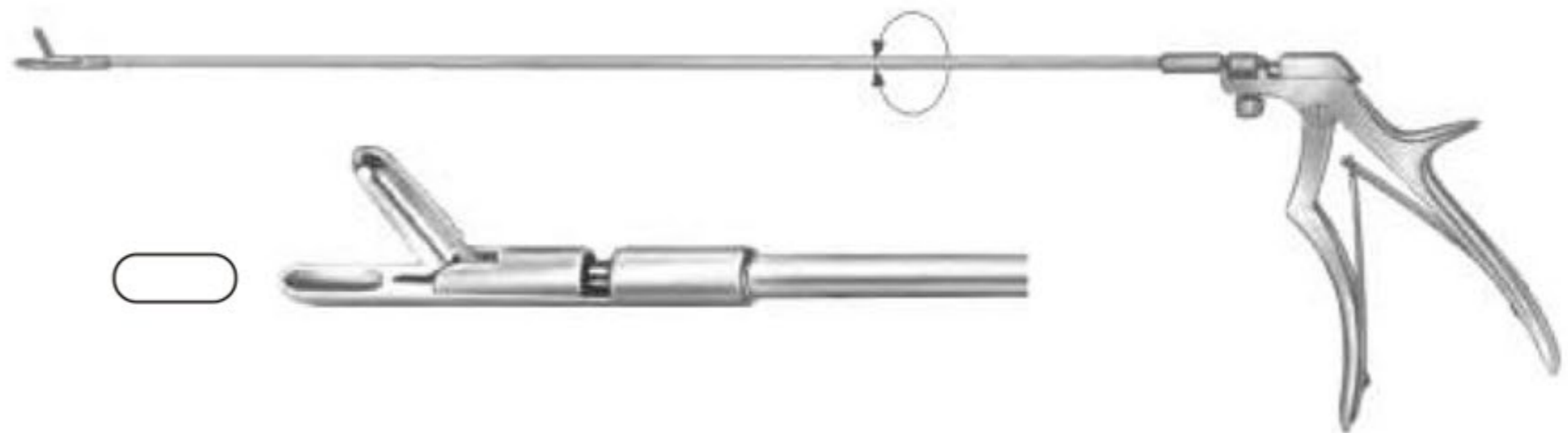

Catalog #	Size
MT-SI-14-293	42 cm (16 1/2")

Yeoman (Turrell) Rectal Biopsy Forcep Without Handle

Rotatable

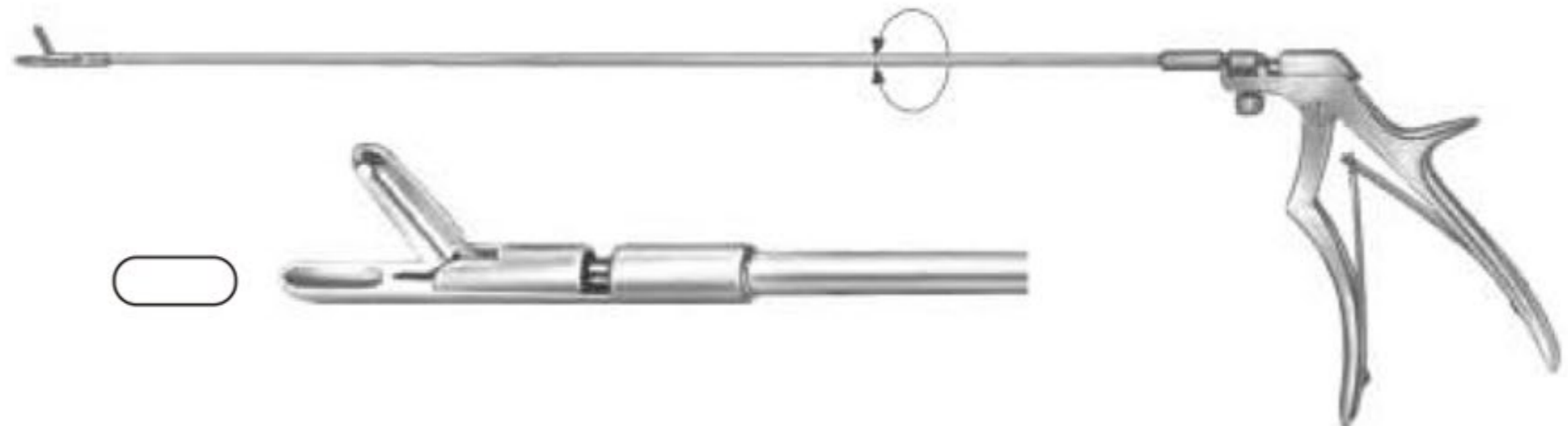

Catalog #	Size
MT-SI-14-294	42 cm (16 1/2")

Yeoman (Turrell) Rectal Biopsy Forcep Without Handle

Rotatable

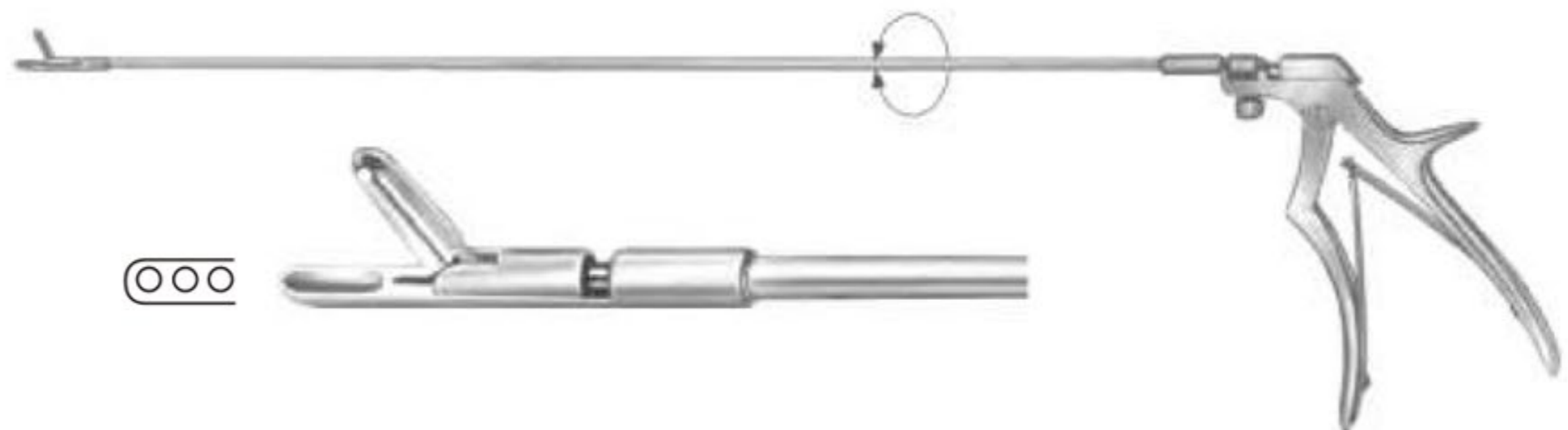

Catalog #	Size
MT-SI-14-295	42 cm (16 1/2")

Yeoman (Turrell) Rectal Biopsy Forcep Without Handle

Rotatable

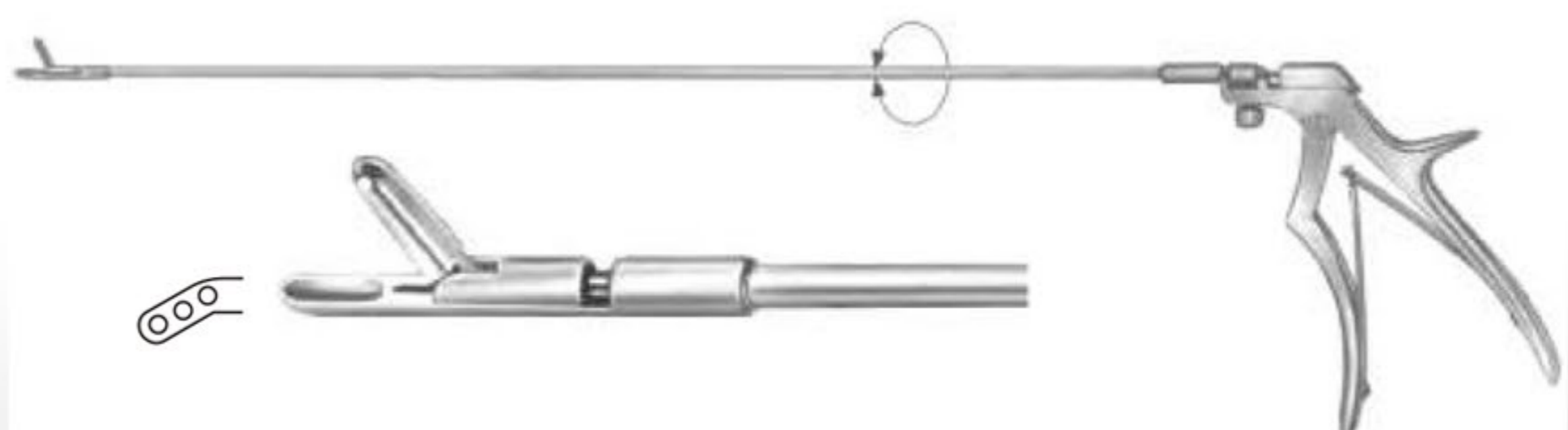

Catalog #	Size
MT-SI-14-296	42 cm (16 1/2")



STOMAC INSTRUMENTS RECTUM

Rectal Biopsy Forceps
Rektum-Biopsiefasszangen
Pinzas para biopsia rectal
Pinces pour biopsie rectale
Pinze per biopsia rettale

Yeoman (Turrell) Rectal Biopsy Forcep Without Handle

Rotatable

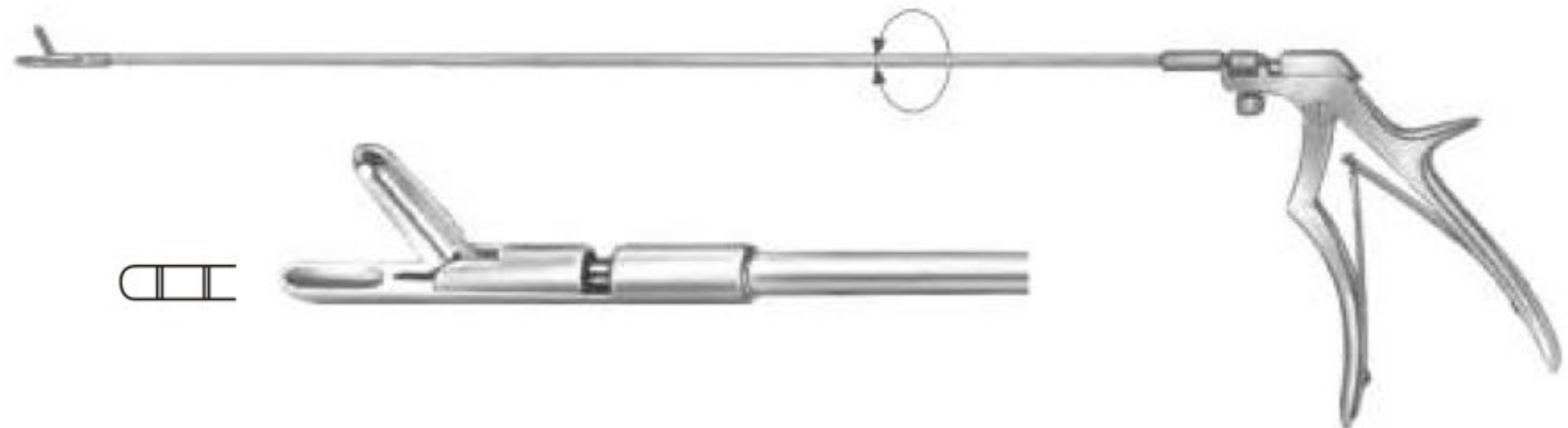

Catalog #	Size
MT-SI-14-297	42 cm (16 1/2")

Handle Only



Catalog #	Size
MT-SI-14-298	N/A

Yeoman (Turrell) Tectal Biopsy Forcep Complete

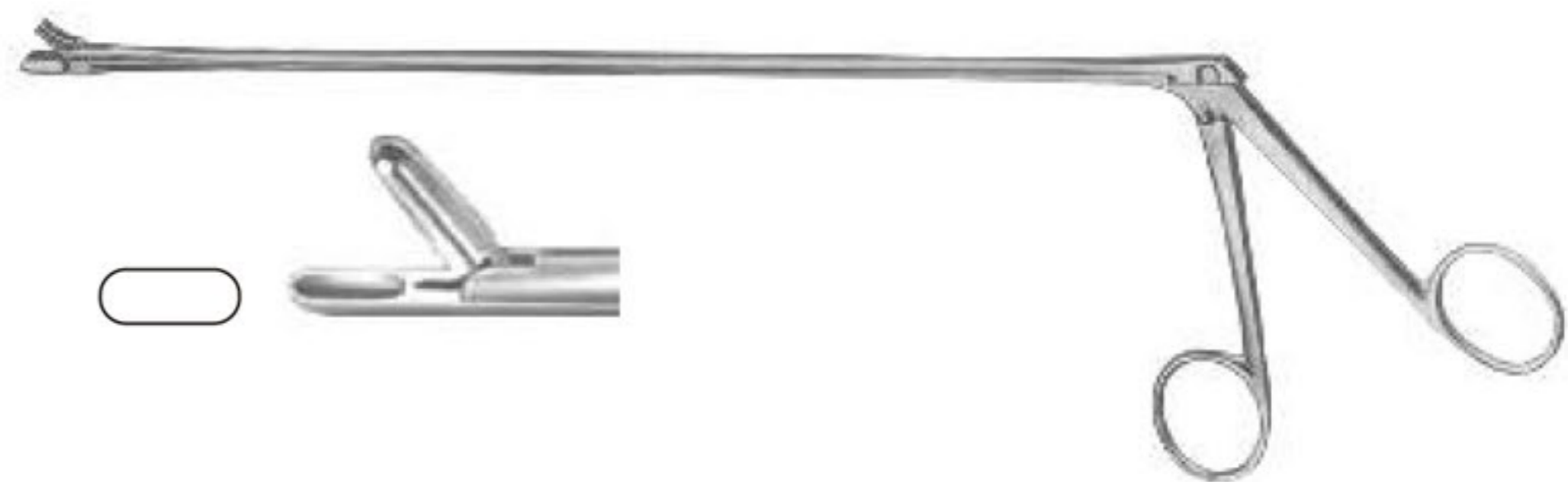

Catalog #	Size
MT-SI-14-299	42 cm (16 1/2")

Yeoman (Turrell) Tectal Biopsy Forcep Complete

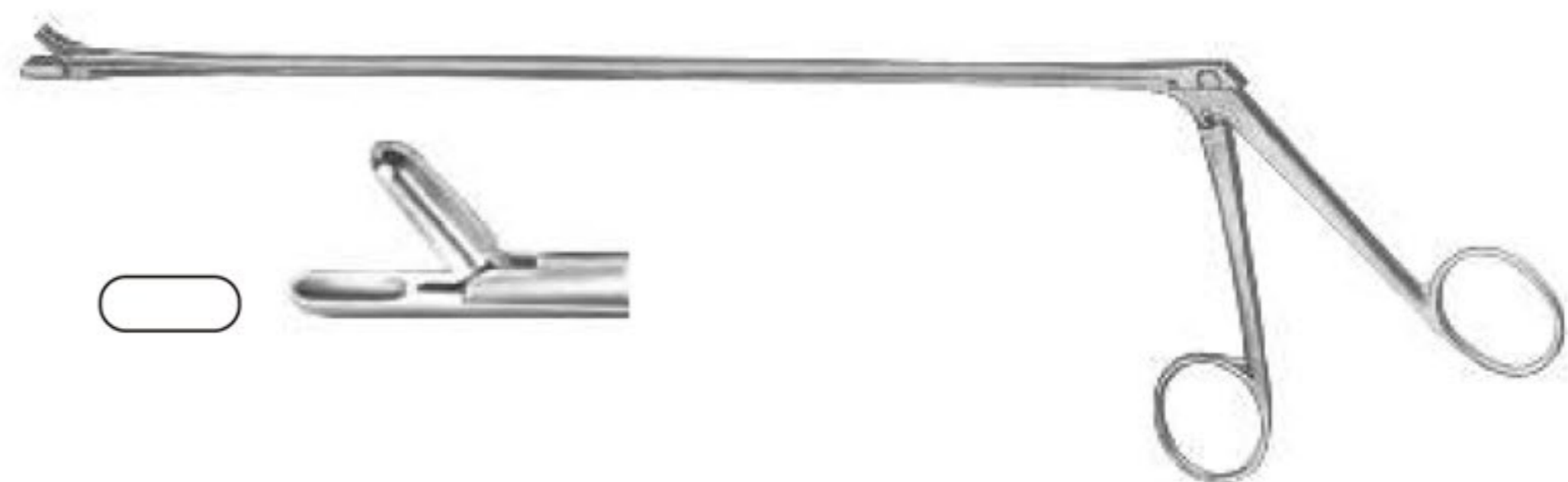

Catalog #	Size
MT-SI-14-300	42 cm (16 1/2")

Yeoman (Turrell) Tectal Biopsy Forcep Complete



Catalog #	Size
MT-SI-14-301	42 cm (16 1/2")



STOMAC INSTRUMENTS RECTUM

Rectal Biopsy Forceps
Rektum-Biopsiefasszangen
Pinzas para biopsia rectal
Pincers pour biopsie rectale
Pinze per biopsia rettale

Yeoman (Turrell) Tectal Biopsy Forcep Complete

Catalog #	Size
MT-SI-14-302	42 cm (16 1/2")



Yeoman (Turrell) Tectal Biopsy Forcep Complete

Catalog #	Size
MT-SI-14-303	42 cm (16 1/2")



MEDICO TECHNOLOGIES



wazirabad road sialkot- 51310 pakistan



0092 523 571 255



0092 523 571 255



info@medico-medtech.com



<http://www.medico-medtech.com>